



---

## Commercial Stream Video Recorder (ADC-CSVR2108P/ADC-CSVR2116P) - Installation Guide

 English

---

English



### Pre-installation checklist

- Pro Series CSVR (included)
- A display with an HDMI input (optional)
- An HDMI cable (optional)
- A display with a VGA input (optional)
- A VGA cable (optional)
- Power cord (included)
- An Ethernet Cat5e cable (included)
- USB Keyboard and Mouse (required)
- Rack mount ears and screws (included, for rack installations)
- Dedicated network switch (optional)
- Ethernet connection to broadband internet (Cable, DSL or Fiber Optic)
- Alarm.com customer account with a service package that supports the Pro Series CSVR

- Login and password for the Alarm.com account to which you will add the Pro Series CSV

**Note:** The Alarm.com Pro Series CSV is compliant with Section 889 of the NDAA and is not produced by any entity identified on the FCC's Covered List.

## Overview

1. Network LED
2. Status LED
3. Power LED
4. USB 3.0 port
5. Power input
6. Power switch
7. HD Out port
8. VGA Out port
9. USB 2.0 ports
10. Client RJ45 port
11. Camera RJ45 port
12. RJ45 PoE Ports

For information about LED statuses, see [LED Guide](#).

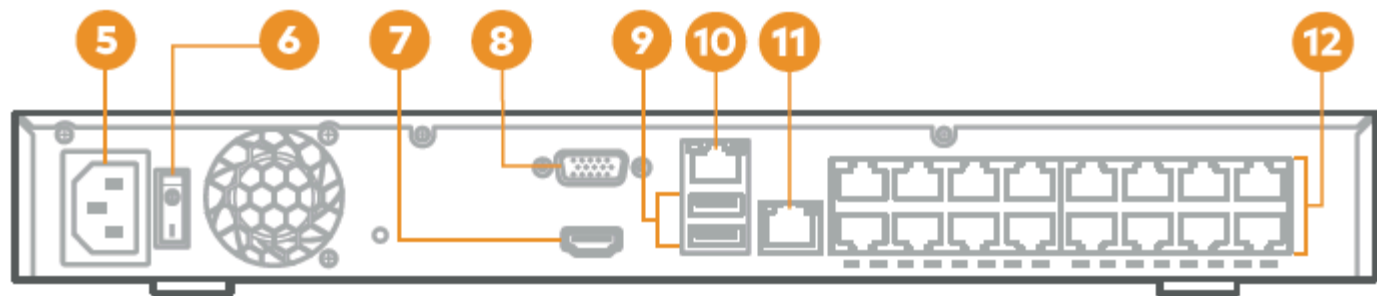
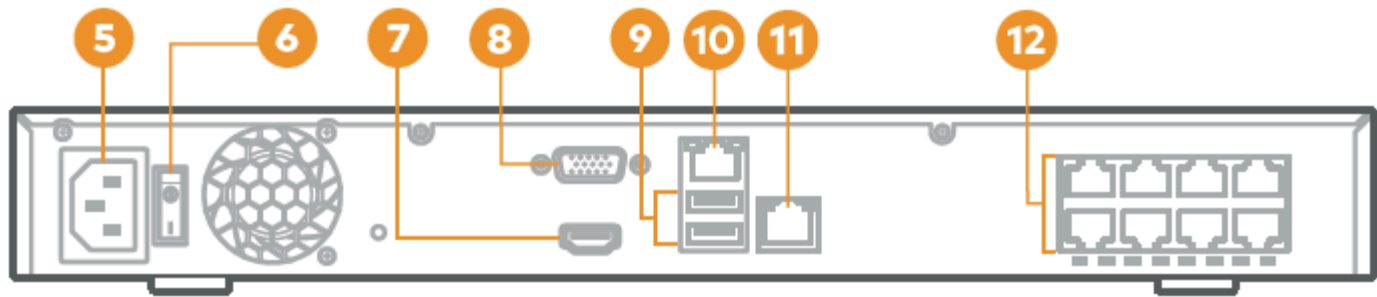

back (ADC-CSV2116P)

## Recommended networking diagram for CSV2108P/CSV2116P

### Router to CSV Client port



\*The router must connect to the port labeled 'Client' on the back of the CSV. Connecting the router to a port labeled "PoE" will cause a network loop and lead to failure of the local network.



### PoE Ports to Cameras



### Alarm.com Pro Series Camera

### Third Party Cameras

**Note:** To optimize performance, Alarm.com recommends using our Pro Series PoE Cameras with the Pro Series CSV.

## Adding the device to the Alarm.com account

1. Using an Ethernet cable, connect the device to the network.
2. If you wish to use a display with your Pro Series CSV, please connect it to one of the *HD Out* ports using an HDMI cable or the VGA port using a VGA cable.
3. Connect the device to a non-switched, grounded power outlet.
4. For the CSV2108P/CSV2116P: Use the switch on the back of the device to turn on your Pro Series CSV.
5. Wait for the device to boot up. A solid green status LED indicates that the device is ready to be added to the

account.

To add the device to the customer account, please use one of the following methods:

### Using the Customer website: ^

1. Using a web browser, enter the following URL: **www.alarm.com/addcamera**. You will need the customer's username and password to log in to the Customer website.
2. Select the Pro Series CSVr from the video device list or enter its MAC address to begin adding the device. The device's MAC address is located on the bottom of the device or on the packaging.
3. Follow the on-screen instructions to finish adding the Pro Series CSVr.

### Using the MobileTech app: ^

1. Log into the MobileTech app.
2. Find the customer account.
3. Tap to expand **Quick Actions**.
4. Tap **Add Device**.
5. Tap **Video**.
6. Follow the on-screen instructions to finish adding the Pro Series CSVr.

You may associate cameras to the device and configure drives and display settings on the Customer website or MobileTech app.

## Mounting the device to a rack

The CSVr2108P/CSVr2116P can be mounted to a standard server rack using the included rack mount kit. The rack mounts are designed to fit into a 1U (rack unit) area.

The kit includes the screws needed to attach the rack mount ears to the device, but does not include the screws needed to mount the device into a rack.

1. Gently pry off the rubber footpads from the bottom of the device.

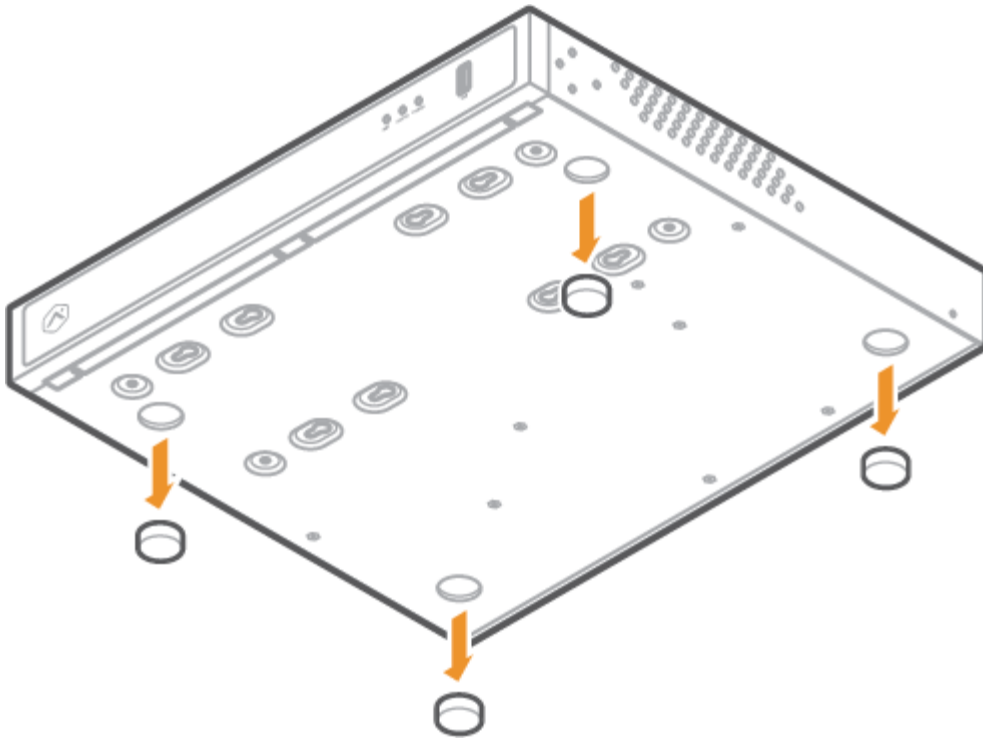

2. Using the included screws and brackets, attach a bracket to each side of the device.

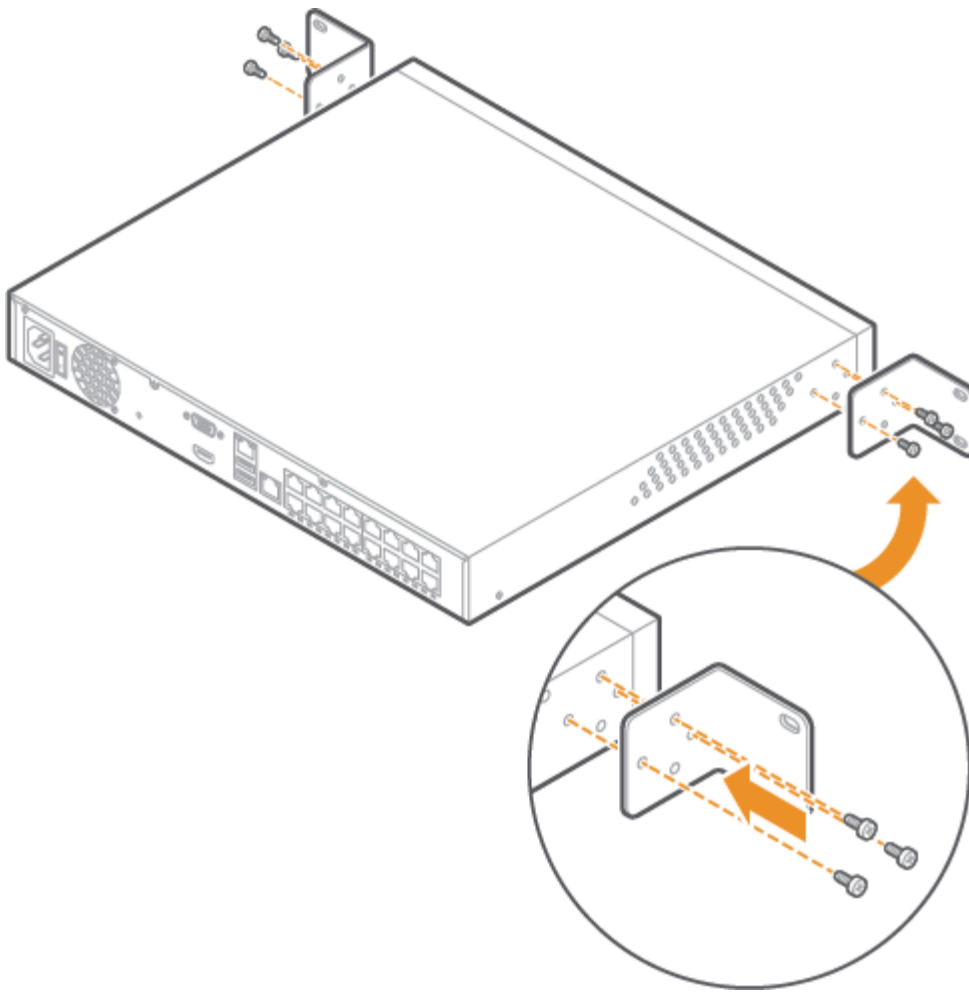

3. Using server rack screws (not included), attach the brackets to each side of the server rack.

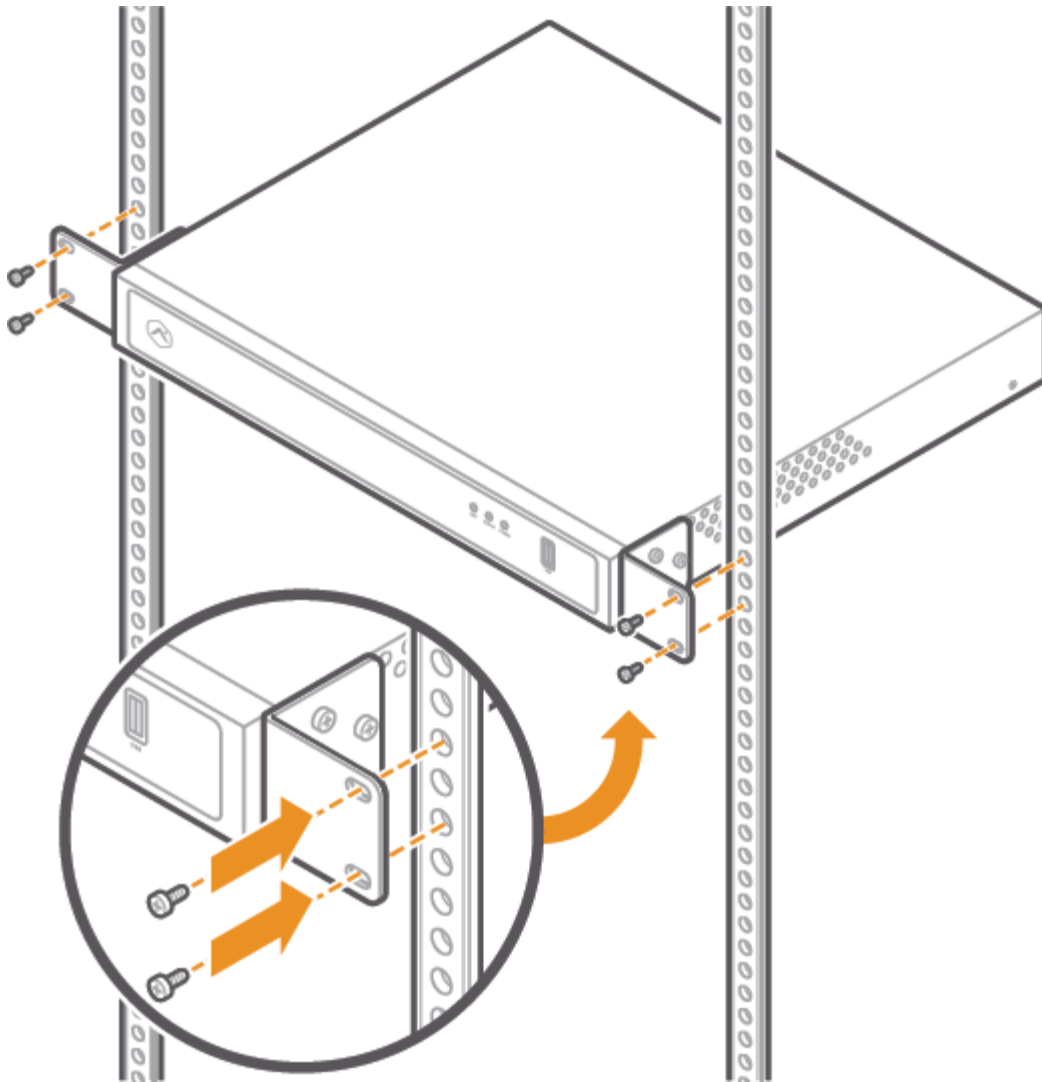

4. Ensure that there is at least 10 in (25 cm) behind the device for proper airflow

## LED guide

### Network LED



LED pattern	Description
Blinking green  	Client uplink active







**LED pattern****Description**

Not illuminated 	Client uplink inactive
--	------------------------

**Power LED****LED pattern****Description**

Solid green 	Powered on
Not illuminated 	Booting or powered off

## Status LED

LED pattern	Description
<p data-bbox="121 315 259 346">Solid green</p> 	<p data-bbox="828 367 1120 399">Connected to Alarm.com</p>
<p data-bbox="121 546 292 577">Blinking green</p> 	<p data-bbox="828 598 1128 630">Local network connection</p>
<p data-bbox="121 777 227 808">Solid red</p> 	<p data-bbox="828 829 998 861">No connection</p>
<p data-bbox="121 1008 300 1039">Not illuminated</p> 	<p data-bbox="828 1060 1096 1092">Booting or powered off</p>

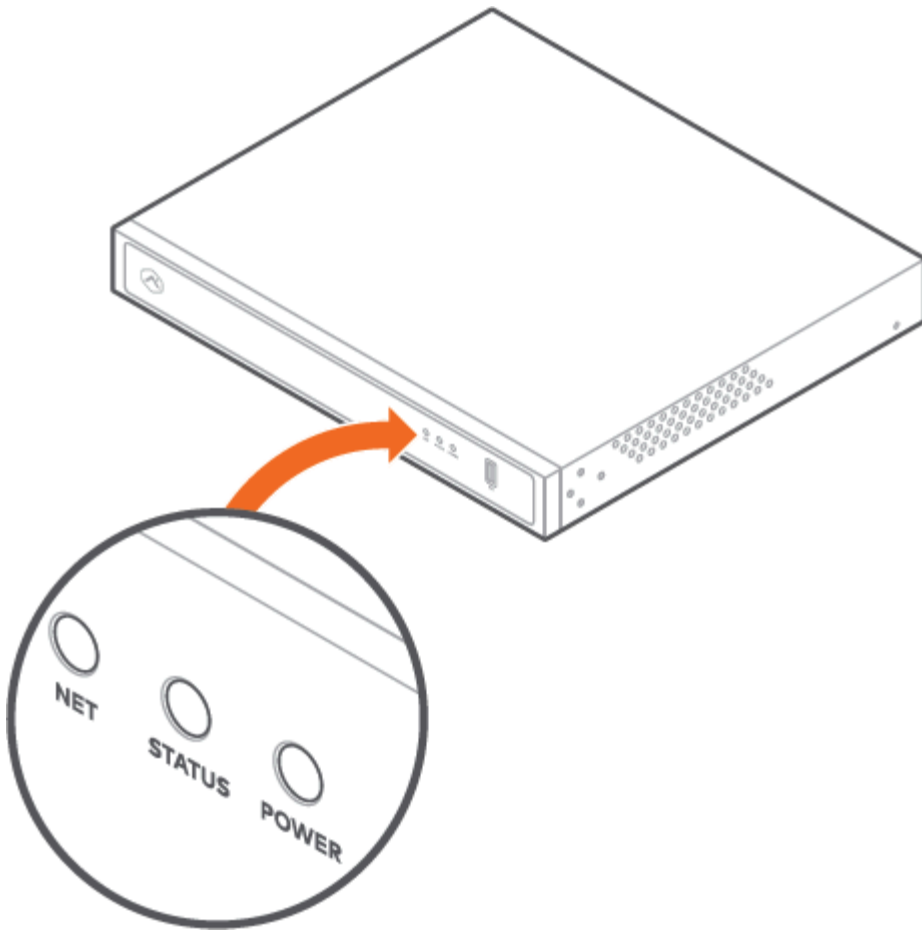

## FCC statements

**Note:** This equipment has been tested and found to comply with the limits for a Class A digital device, pursuant to part 15 of the FCC Rules. These limits are designed to provide reasonable protection against harmful interference when the equipment is operated in a commercial environment.

This equipment generates, uses, and can radiate radio frequency energy and, if not installed and used in accordance with the instruction manual, may cause harmful interference to radio communications. Operation of this equipment in a residential area is likely to cause harmful interference in which case the user will be required to correct the interference at his own expense.

## UL statements

- The NVR is only to be connected to PoE networks without routing to outside plants.
- Verify that all maintenance and repair work is handled by qualified personnel such as electrical engineers or network specialists.
- Connect the system to an earthed main outlet.

**Important:** The total power budget for the ADC-CSVR2108P POE ports is 120W, ADC-CSVR2116P POE ports is 200W.

The maximum output for each port is 30W. If a PoE device draws more than 30W, then PoE Power will be disabled on that port.

**Caution:** Risk of explosion if battery is replaced by an incorrect type. Dispose of used batteries according to the instructions.

Changes or modifications not expressly approved by the party responsible for compliance could void the user's authority to operate this equipment.

**Rated:**

- ADC-CSVR2108P - 100-240Vac, 60-50Hz, 3.5A, 190W
- ADC-CSVR2116P - 100-240Vac, 60-50Hz, 6-3A, 280W

---

## Español



### Lista de verificación previa a la configuración

- Grabadora de video comercial Pro Series (incluida)
- Una pantalla con una entrada HDMI (opcional)
- Un cable HDMI (opcional)
- Una pantalla con una entrada VGA (opcional)
- Un cable VGA (opcional)
- Cable de alimentación (incluido)
- Un cable Ethernet CAT5e (incluido)
- Teclado y mouse USB (requeridos)
- Tornillos y soportes para montaje en estante (incluidos para la instalación en estante)

- Conmutador de red dedicado (opcional)
- Conexión por Ethernet a Internet de banda ancha (cable, DSL o fibra óptica)
- Cuenta de cliente de Alarm.com con un paquete de servicios compatible con la grabadora de video comercial Pro Series
- Usuario y contraseña de la cuenta de Alarm.com a la cual se agregará la grabadora de video comercial Pro Series

## Descripción general

1. LED de red
2. LED de estado
3. LED de encendido
4. Puerto USB 3.0
5. Entrada de alimentación
6. Interruptor de alimentación
7. Puerto de salida HD
8. Puerto de salida VGA
9. Puertos USB 2.0
10. Puerto RJ45 para cliente
11. Puerto RJ45 para cámara
12. Puertos PoE RJ45

Para obtener información sobre los estados de los indicadores LED, consulte la [Guía de referencia de indicadores LED](#).

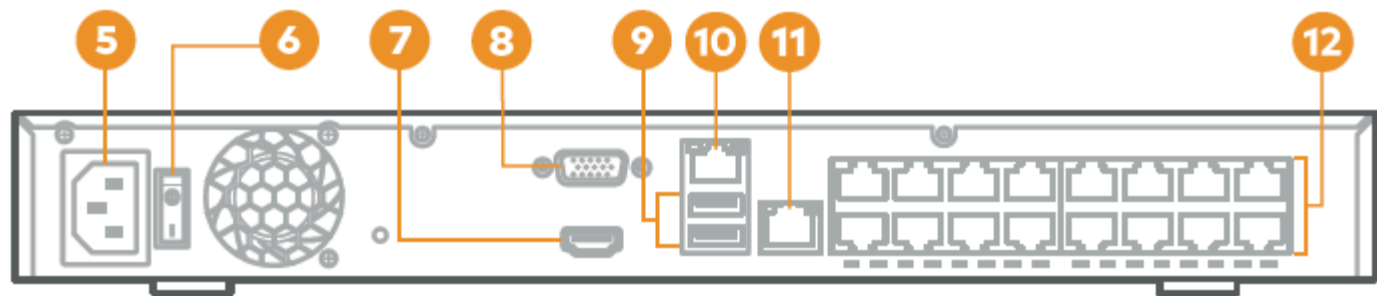
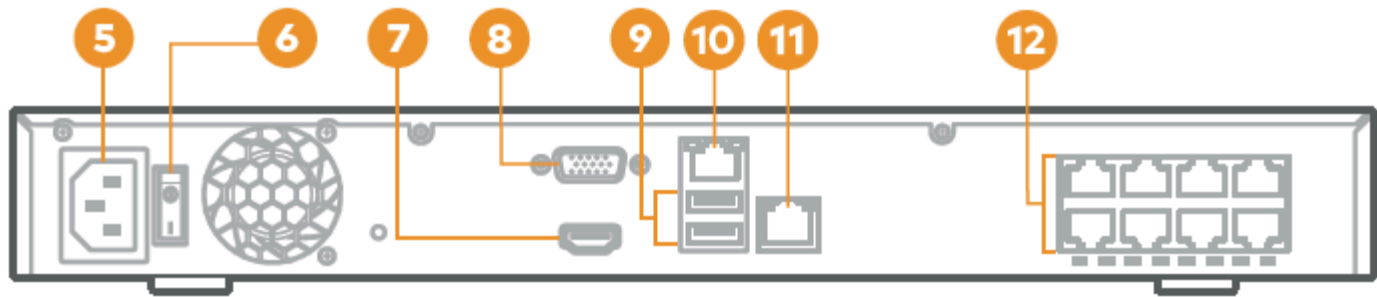

back (ADC-CSV2116P)

## Diagrama de red recomendado para los modelos CSVR2108P/CSV2116P

### Router to CSVR Client port



\*The router must connect to the port labeled 'Client' on the back of the CSVR. Connecting the router to a port labeled "PoE" will cause a network loop and lead to failure of the local network.



### PoE Ports to Cameras



### Alarm.com Pro Series Camera

### Third Party Cameras

**Nota:** para optimizar el rendimiento, Alarm.com recomienda usar nuestras cámaras PoE Pro Series con la grabadora de video comercial Pro Series.

## Agregar el dispositivo a la cuenta de Alarm.com

1. Utilizando un cable de Ethernet, conecte el dispositivo a la red.
2. Si desea usar una pantalla con su grabadora de video comercial Pro Series, conéctela a uno de los *puertos de salida HD* mediante un cable HDMI, o al puerto VGA mediante un cable VGA.
3. Conecte el dispositivo a una toma de corriente no conmutada y con conexión a tierra.
4. Para los modelos CSVR2108P/CSV2116P: use el interruptor en la parte posterior del dispositivo para encender

su grabadora de video comercial Pro Series.

5. Espere a que el dispositivo se inicie. Un LED de estado verde continuo indica que el dispositivo está listo para agregarse a la cuenta.

Para agregar el dispositivo a la cuenta de customer account, utilice uno de los siguientes métodos:

### **Método 1: Customer website** ^

1. En un navegador web, ingrese la siguiente dirección URL: **www.alarm.com/addcamera**. Necesitará el nombre de usuario y la contraseña del cliente para acceder al Customer website.
2. Seleccione la grabadora de video comercial Pro Series en la lista de dispositivos de video o ingrese su dirección MAC para empezar a agregar el dispositivo. La dirección MAC del dispositivo se indica en la parte inferior del mismo o en el empaque.
3. Siga las instrucciones en pantalla para terminar de agregar la grabadora de video comercial Pro Series.

### **Método 2: MobileTech app** ^

1. Inicie sesión en MobileTech app.
2. Busque la customer account.
3. Toque para expandir **Acciones rápidas**.
4. Toque **Agregar dispositivo**.
5. Toque **Video**.
6. Siga las instrucciones en pantalla para terminar de agregar la grabadora de video comercial Pro Series.

Puede vincular cámaras al dispositivo y configurar las unidades de almacenamiento y las opciones de visualización en el Customer website o en la MobileTech app.

## **Montar el dispositivo en un estante**

Los modelos CSV2108P/CSV2116P pueden montarse en un estante de servidor estándar usando el kit de montaje en estante, el cual viene incluido. Los soportes para estante están diseñados para ajustarse a un área de 1U (unidad de estante).

El kit incluye los tornillos necesarios para fijar los soportes de montaje al dispositivo, pero no incluye los tornillos necesarios para montar el dispositivo en un estante.

1. Haga palanca suavemente para retirar las almohadillas de goma de la base del dispositivo.



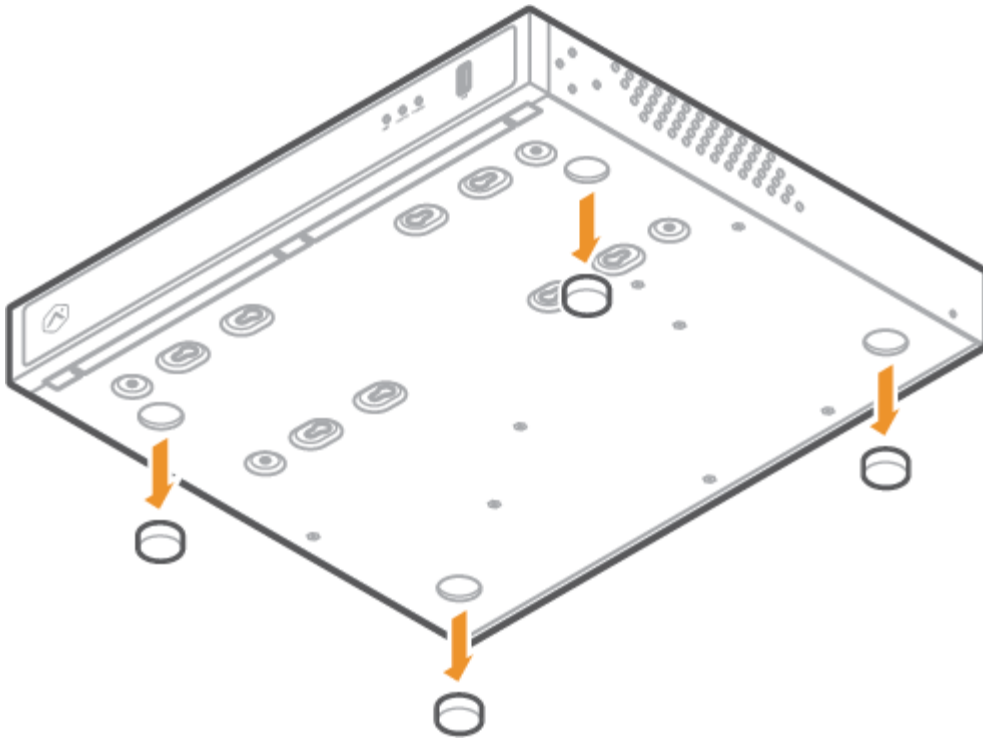

2. Utilizando los tornillos y soportes incluidos, fije un soporte a cada lado del dispositivo.

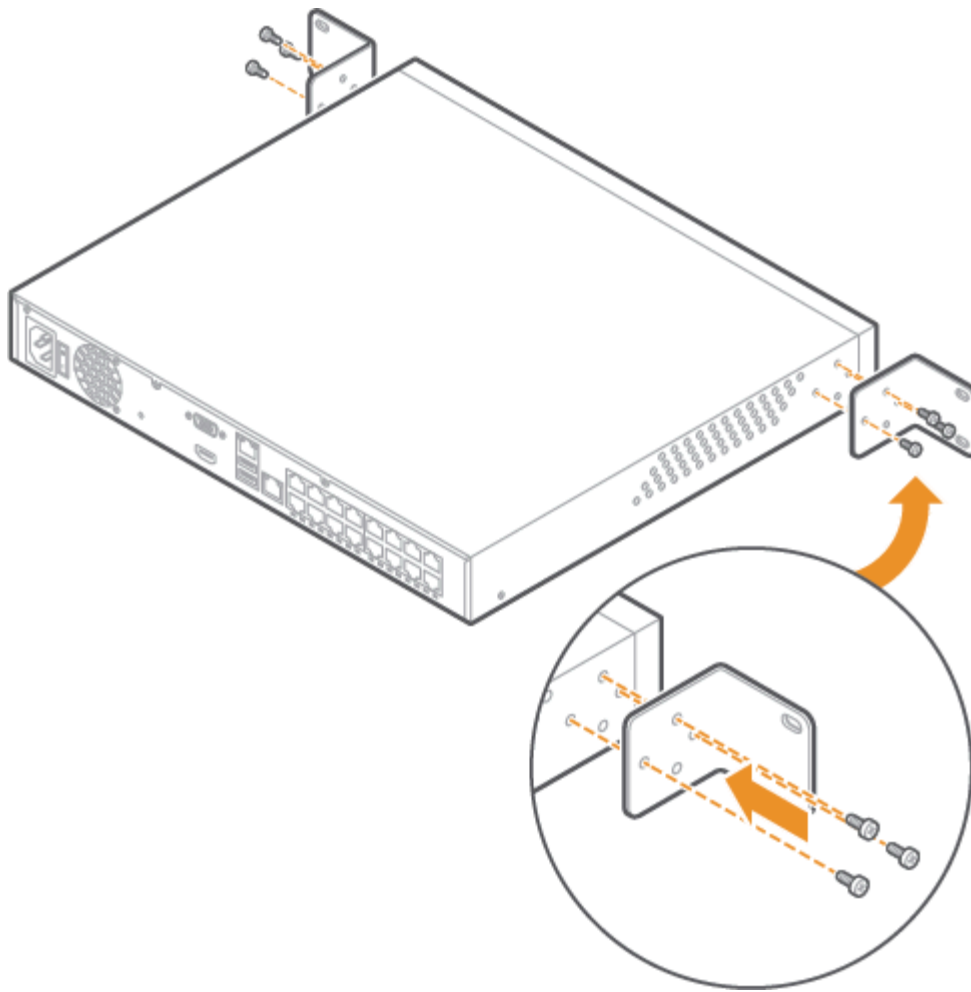

3. Con tornillos para estantes de servidor (no incluidos), fije los soportes a cada lado del estante de servidor.

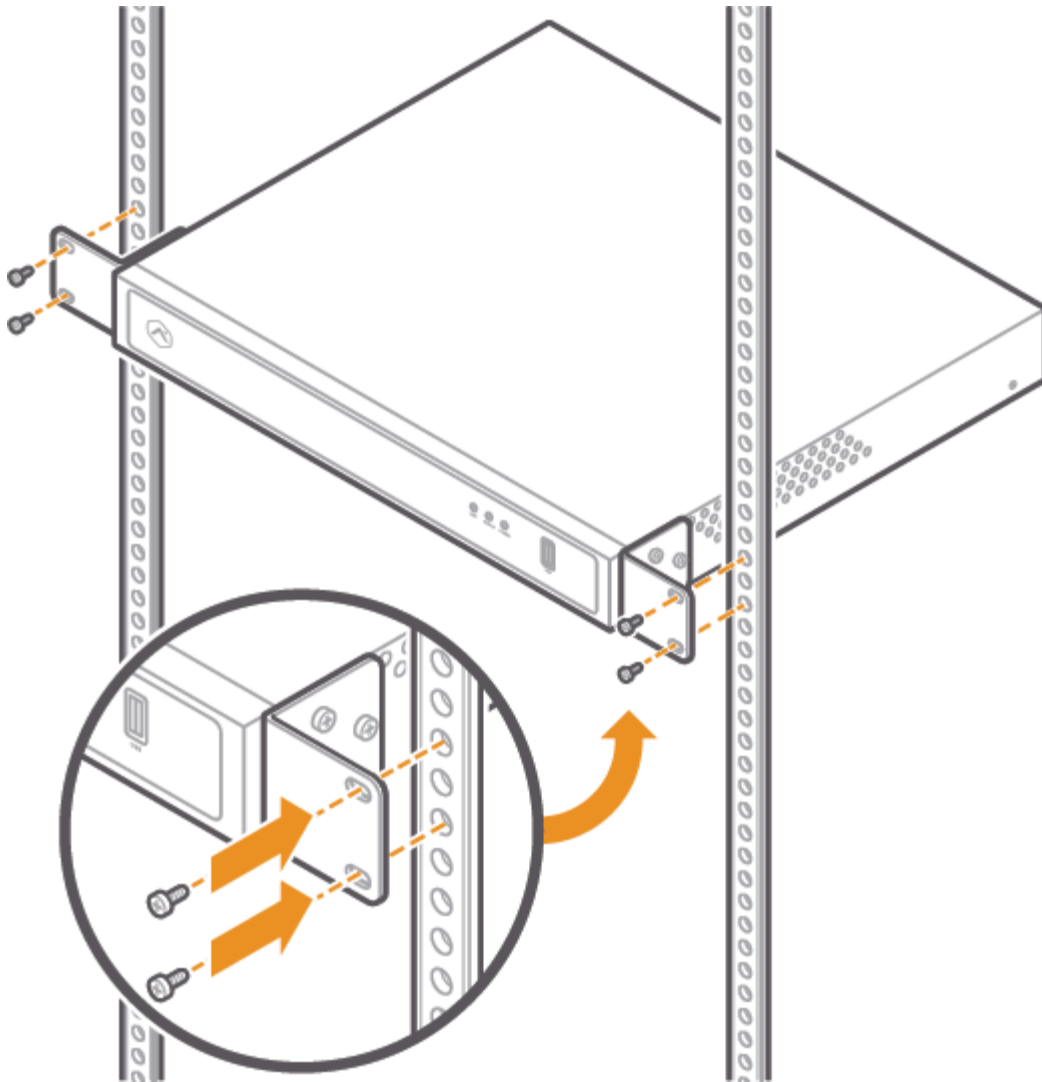

4. Asegúrese de dejar al menos 25 cm (10 pulgadas) detrás del dispositivo para permitir un flujo de aire adecuado.

## Guía de referencia de indicadores LED



### LED de red

Patrón de LED	Descripción
Verde intermitente  	Transmisión al cliente activa





**Patrón de LED****Descripción**

LED apagado 	Transmisión al cliente no activa
--	----------------------------------

**LED de encendido****Patrón de LED****Descripción**

Verde continuo 	Dispositivo encendido
LED apagado 	Arranque en curso, o dispositivo apagado

## LED de estado

Patrón de LED	Descripción
Verde continuo 	Dispositivo conectado a Alarm.com
Verde intermitente 	Conexión de red local
Rojo continuo 	Sin conexión
LED apagado 	Inicio en curso o dispositivo apagado

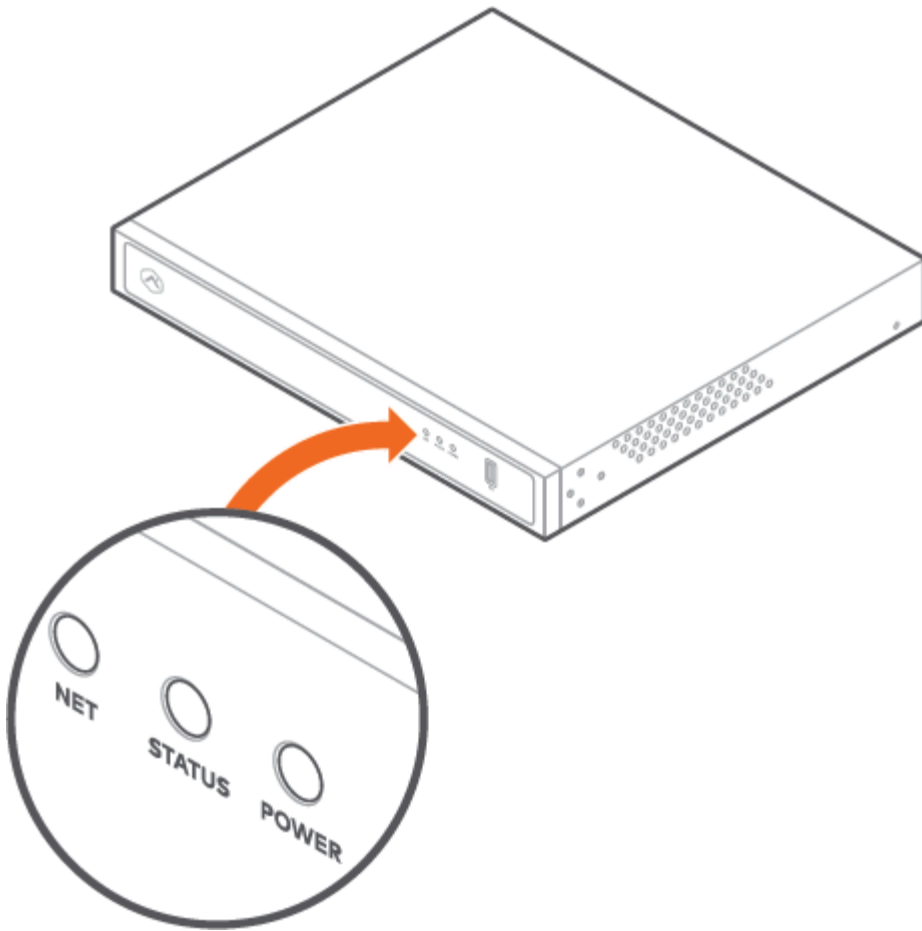

## Avisos

Nota: este equipo ha sido probado y cumple con los límites para un dispositivo digital de Clase A, de acuerdo con el apartado 15 de las normativas de la Comisión Federal de Comunicaciones (FCC). Estos límites están diseñados para proporcionar una protección razonable contra interferencias dañinas cuando el equipo se utiliza en un entorno comercial. Este equipo genera, usa y puede irradiar energía de radiofrecuencia y, si no se instala y usa de acuerdo con el manual, puede causar interferencias en las comunicaciones de radio. La utilización de este equipo en una zona residencial puede ocasionar interferencias dañinas y, en tal caso, el usuario deberá corregir dichas interferencias por cuenta propia.

Clasificación:

- ADC-CSVR2108P - 100-240 VCA, 60-50 Hz, 3.5 A, 190 W
- ADC-CSVR2116P - 100-240 VCA, 60-50 Hz, 6-3 A, 280 W

La grabadora de video comercial sólo debe conectarse a redes PoE sin enrutamiento a plantas exteriores. Asegúrese de que todo el trabajo de mantenimiento y reparación sea realizado por personal calificado, como ingenieros eléctricos o especialistas en redes. Conecte el sistema a una toma de corriente principal con conexión a tierra.

**Precaución:** existe riesgo de explosión si la batería se reemplaza por una del tipo incorrecto. Deseche las baterías

usadas de acuerdo con las instrucciones.

**Importante:** la capacidad total de energía de los puertos PoE del modelo ADC-CSVR2108P es de 120 W, y de 200 W en los puertos PoE del modelo ADC-CSVR2116P.

La potencia de salida máxima de cada puerto es de 30 W. Si un dispositivo PoE consume más de 30 W, se desactivará la alimentación PoE en ese puerto.

Los cambios o modificaciones no aprobados expresamente por la parte responsable del cumplimiento podrían anular la autoridad del usuario para operar este equipo.

---

## Français



### Aide mémoire avant l'installation

- Un enregistreur CSVR série Pro (inclus)
- Un écran avec une entrée HDMI (facultatif)
- Un câble HDMI (facultatif)
- Un écran avec une entrée VGA (facultatif)
- Un câble VGA (facultatif)
- Un cordon d'alimentation (inclus)
- Un câble Ethernet Cat5e (inclus)
- Un clavier et une souris USB (requis)
- Des oreilles de montage et des vis pour installation sur bâti (incluses, pour les installations sur bâti)
- Un commutateur réseau dédié (facultatif)
- Une connexion Ethernet à l'Internet large bande (câble, DSL ou fibre optique)
- Un compte client de Alarm.com avec forfait de service qui prend en charge l'enregistreur CSVR série Pro
- Un identifiant et un mot de passe du compte de Alarm.com auquel vous ajouterez l'enregistreur CSVR série Pro

## **Vue d'ensemble**

1. Voyant du réseau
2. Voyant d'état
3. Voyant d'alimentation
4. Port USB 3.0
5. Entrée d'alimentation
6. Interrupteur
7. Port de sortie HD
8. Port de sortie VGA
9. Ports USB 2.0
10. Port RJ45 pour client
11. Port RJ45 pour caméra
12. Ports RJ45 pour alimentation électrique par Ethernet (PoE)

Pour plus d'informations sur l'état des voyants, reportez-vous à la section [Guide des voyants](#).



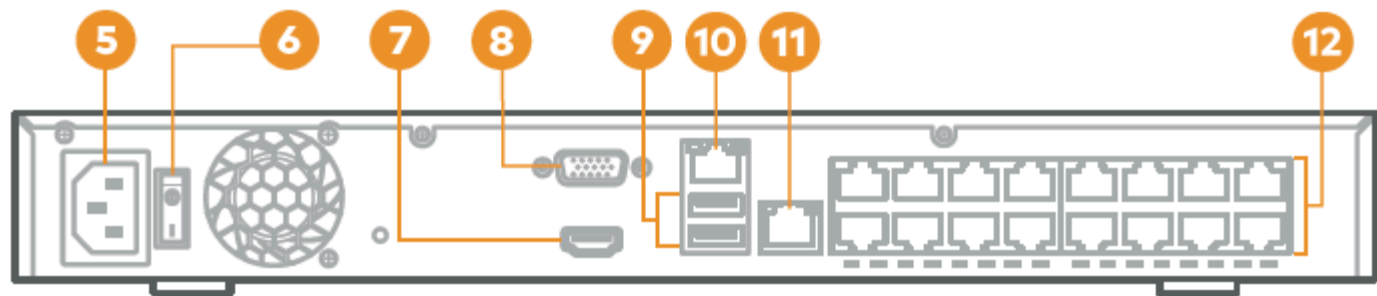
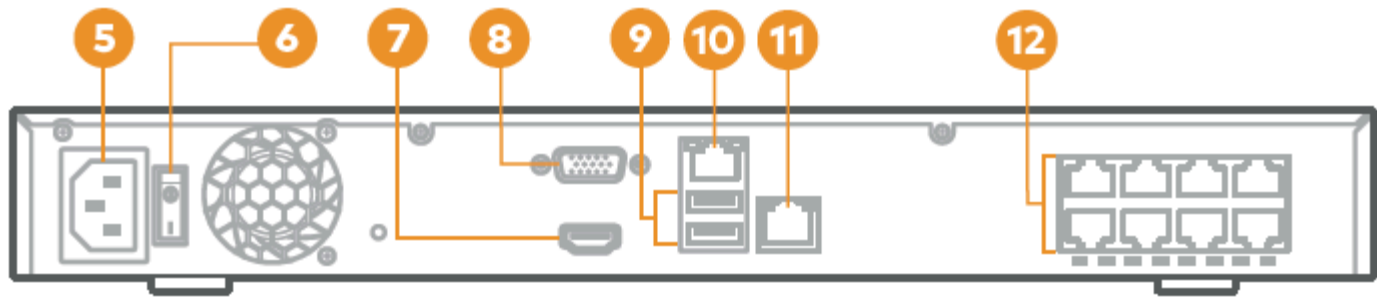

back (ADC-CSV2116P)

## Diagramme de mise en réseau recommandée pour les appareils CSVR2108P/CSV2116P

### Router to CSVR Client port



\*The router must connect to the port labeled 'Client' on the back of the CSVR. Connecting the router to a port labeled "PoE" will cause a network loop and lead to failure of the local network.



### PoE Ports to Cameras



### Alarm.com Pro Series Camera

### Third Party Cameras

**Remarque :** Pour optimiser le rendement des appareils, Alarm.com recommande l'utilisation de nos caméras PoE de série Pro avec l'enregistreur CSVR de série Pro.

## Ajout de l'appareil au compte de Alarm.com

1. À l'aide d'un câble Ethernet, branchez l'appareil au réseau.
2. Si vous souhaitez utiliser un écran avec votre enregistreur CSVR série Pro, veuillez le brancher à l'un des ports de sortie HD avec un câble HDMI ou au port VGA avec un câble VGA.
3. Branchez l'appareil à une prise de courant mise à la terre et non commutée.
4. Pour un appareil CSVR2108P/CSV2116P : Utilisez l'interrupteur à l'arrière de l'appareil pour allumer votre

enregistreur CSVR série Pro.

5. Attendez que l'appareil démarre. Un voyant d'état vert fixe indique que l'appareil est prêt à être ajouté au compte.

Pour ajouter l'appareil au compte customer account, veuillez utiliser l'une des méthodes suivantes :

#### **Méthode 1 : Customer website**^

1. Entrez l'adresse URL **www.alarm.com/addcamera** dans un navigateur Web. Vous aurez besoin du nom d'utilisateur et du mot de passe du client pour ouvrir une session sur Customer website.
2. Sélectionnez l'enregistreur CSVR série Pro dans la liste des appareils vidéo ou entrez son adresse MAC pour commencer le processus d'ajout. L'adresse MAC se trouve sous l'appareil ou sur l'emballage.
3. Suivez les instructions à l'écran pour terminer le processus d'ajout de l'enregistreur CSVR série Pro.

#### **Méthode 2 : MobileTech app**^

1. Ouvrez une session dans l'application MobileTech app.
2. Trouvez le compte customer account.
3. Touchez pour ouvrir le menu **Actions rapides**.
4. Touchez l'option **Ajouter un dispositif**.
5. Touchez l'option **Vidéo**.
6. Suivez les instructions à l'écran pour terminer le processus d'ajout de l'enregistreur CSVR série Pro.

Vous pouvez associer des caméras à l'enregistreur et configurer les lecteurs et les paramètres d'affichage sur Customer website ou dans l'application MobileTech app.

### **Installation de l'appareil sur un bâti**

L'appareil CSVR2108P/CSV2116P peut être installé sur un bâti de serveur standard à l'aide de la trousse incluse pour installation sur bâti. Les bâtis sont conçus pour s'adapter à un espace 1U (unité de bâti).

La trousse comprend les vis nécessaires pour fixer les oreilles de montage à l'appareil, mais n'inclut pas les vis requises pour installer l'appareil sur le bâti.

1. Soulevez doucement les pieds en caoutchouc situés dans le bas de l'appareil.

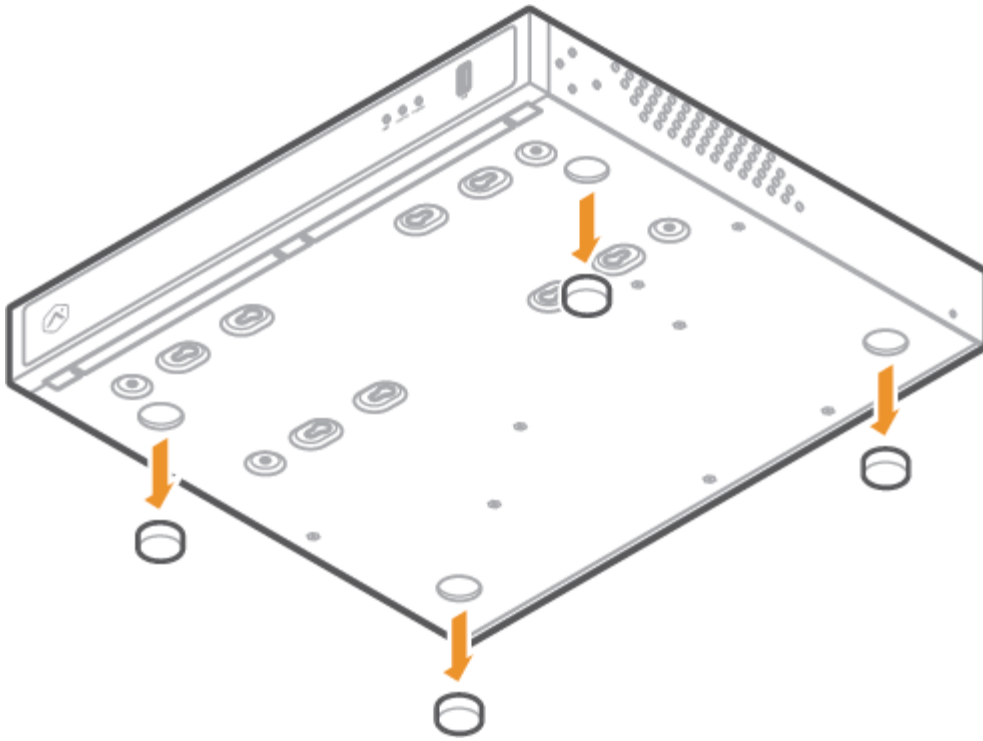

2. À l'aide des vis et des supports fournis, fixez un support de chaque côté de l'appareil.

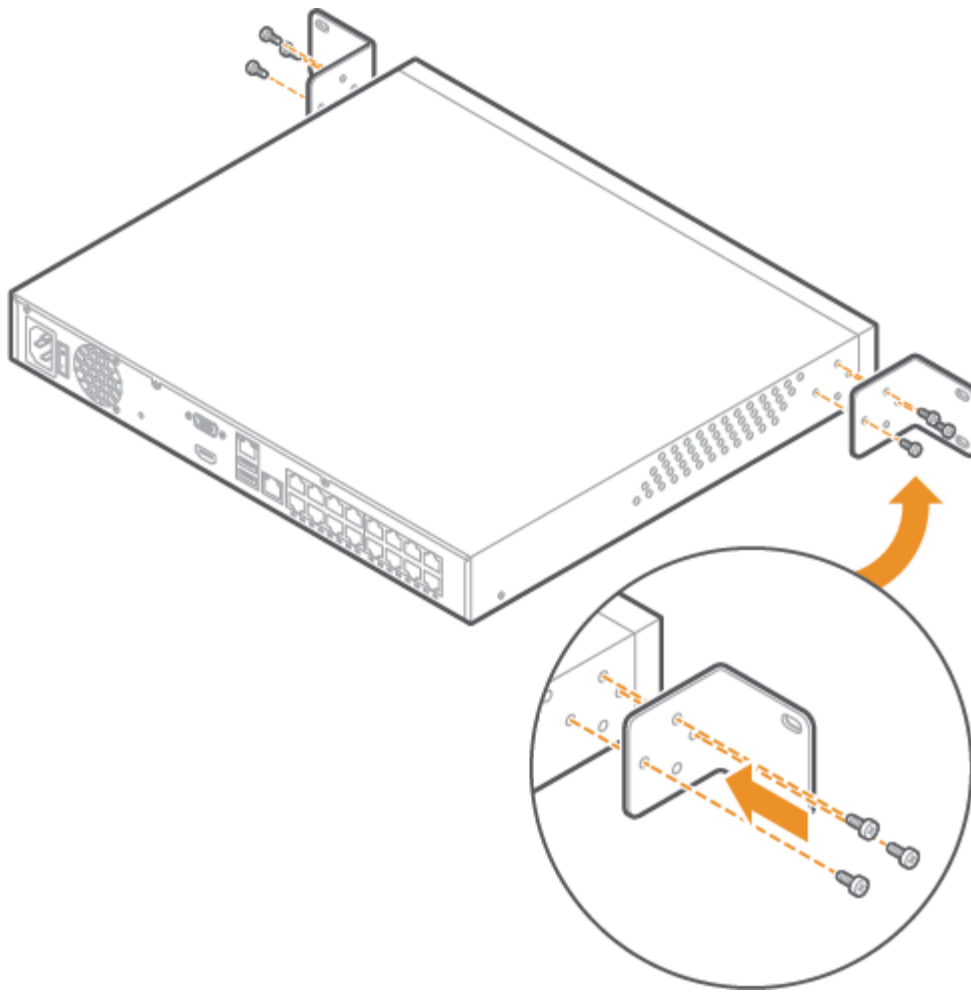

3. À l'aide de vis pour bâti de serveur (non incluses), fixez les supports de chaque côté du bâti.

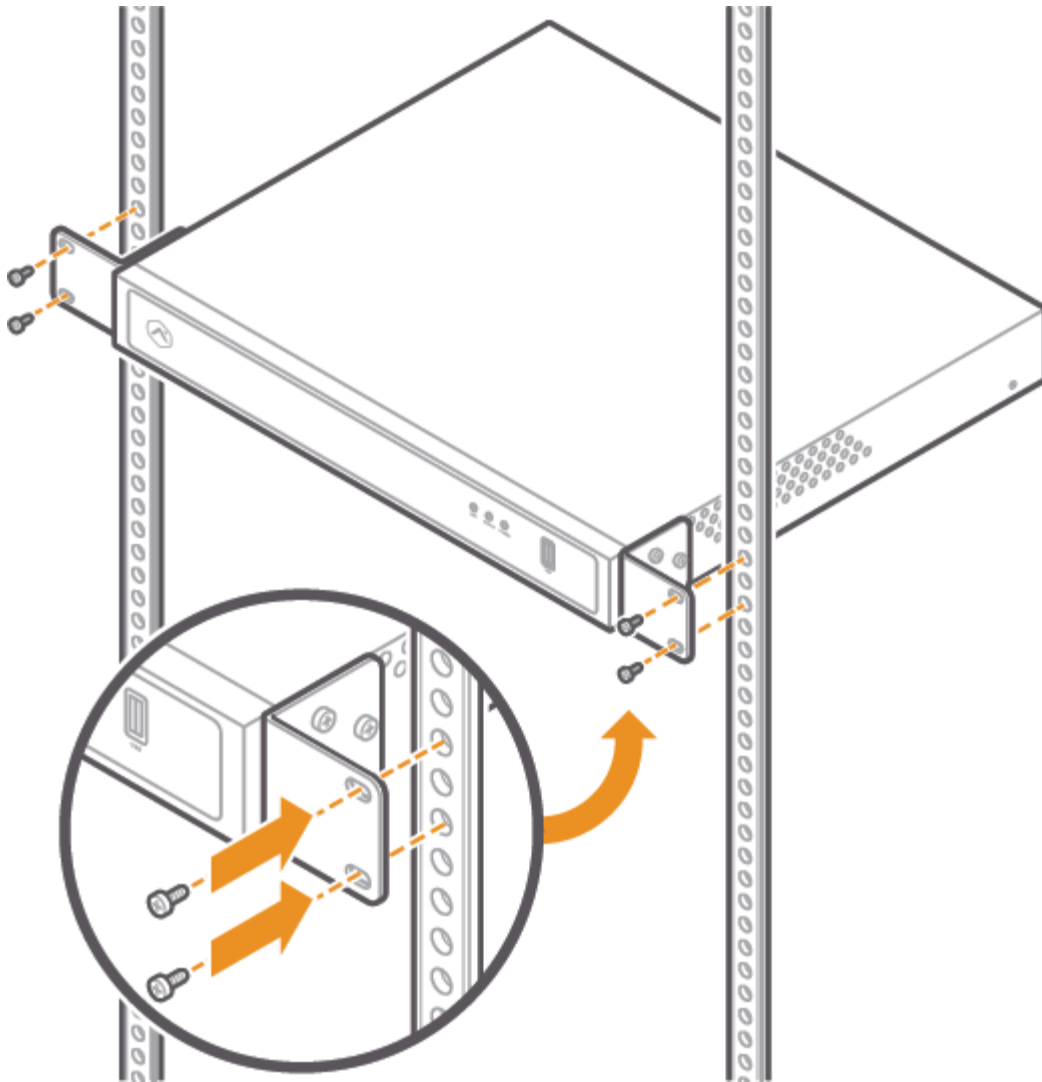

4. Assurez-vous de laisser au moins 25 cm (10 po) derrière l'appareil pour garantir une bonne circulation d'air.

## Guide des voyants



### Voyant du réseau

État des voyants	Description
Vert clignotant  	Liaison montante active du client





**État des voyants****Description**

Éteint 	Liaison montante inactive du client
---	-------------------------------------

**Voyant d'alimentation****État des voyants****Description**

Vert fixe 	Sous tension et allumé
Éteint 	En cours de démarrage ou hors tension

## Voyant d'état

État des voyants	Description
Vert fixe 	Connecté à Alarm.com
Vert clignotant 	Connexion au réseau local
Rouge fixe 	Aucune connexion
Éteint 	En cours de démarrage ou hors tension



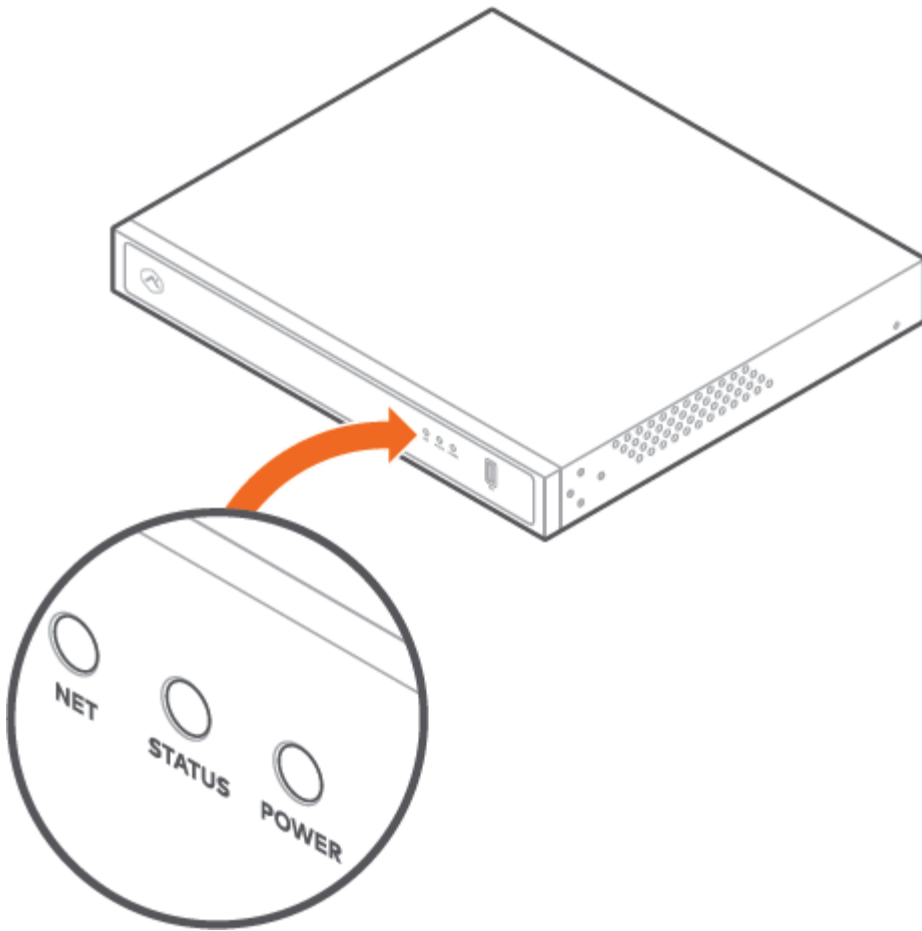

## Avis

**Remarque :** Cet appareil a été testé et il a été déclaré conforme aux limites d'un appareil numérique de classe B, conformément à la section 15 du Règlement de la FCC. Ces limites sont conçues pour fournir une protection raisonnable contre les interférences nuisibles lorsque l'équipement est utilisé dans un environnement commercial. Cet équipement génère, utilise et peut émettre une énergie de radiofréquence et, s'il n'est pas installé et utilisé conformément au manuel d'instructions, il peut causer des interférences nuisibles pour les communications radio. L'utilisation de cet équipement dans une zone résidentielle est susceptible de provoquer des interférences nuisibles, auquel cas l'utilisateur devra corriger les interférences à ses propres frais.

Classement :

- ADC-CSVR2108P - 100 à 240 V c.a., 60 à 50 Hz, 3,5 A, 190 W
- ADC-CSVR2116P - 100 à 240 V c.a., 60 à 50 Hz, 6 à 3 A, 280 W

L'enregistreur CSVR ne doit être connecté qu'à des réseaux à alimentation électrique par Ethernet sans acheminement vers des installations extérieures. Assurez-vous que tous les travaux d'entretien et de réparation sont effectués par un personnel qualifié, tel que des ingénieurs en électricité ou des spécialistes en réseau. Branchez le système à une prise de courant principale mise à la terre.

**Attention** : Risque d'explosion si la pile est remplacée par une pile de type inapproprié. Éliminez les piles usagées conformément aux instructions.

**Important** : Le budget énergétique total pour les ports PoE du modèle ADC-CSVR2108P est de 120 W et de 200 W pour les ports PoE de modèle ADC-CSVR2116P.

La sortie maximale pour chacun des ports est de 30 W. Si un appareil à alimentation électrique par Ethernet consomme plus de 30 W, l'alimentation sera désactivée sur ce port.

Toute modification non expressément approuvée par la partie responsable de la conformité pourrait annuler l'autorisation donnée à l'utilisateur de faire fonctionner cet appareil.

---

## Português



### Lista de verificação pré-instalação

- CSVN Pro Series (fornecido)
- Um monitor com entrada HDMI (opcional)
- Um cabo HDMI (opcional)
- Um monitor com entrada VGA (opcional)
- Um cabo VGA (opcional)
- Cabo de alimentação (fornecido)
- Um cabo Ethernet Cat5e (fornecido)
- Teclado e mouse USB (obrigatório)
- Suportes e parafusos para montagem em rack (fornecidos, para instalações em rack)
- Switch de rede dedicado (opcional)
- Conexão Ethernet à internet banda larga (cabo, DSL ou fibra óptica)
- Conta de cliente Alarm.com com um pacote de serviços compatível com CSVN Pro Series

- Login e senha da conta Alarm.com à qual você adicionará o CSVR Pro Series

## Visão geral

1. LED de rede
2. LED de status
3. LED de alimentação
4. Porta USB 3.0
5. Entrada de alimentação
6. Switch de alimentação
7. Porta HD Out
8. Porta VGA Out
9. Portas USB 2.0
10. Porta RJ45 do cliente
11. Porta RJ45 da câmera
12. Portas PoE RJ45

Para obter informações sobre os status de LED, consulte a [Legenda dos LEDs](#).

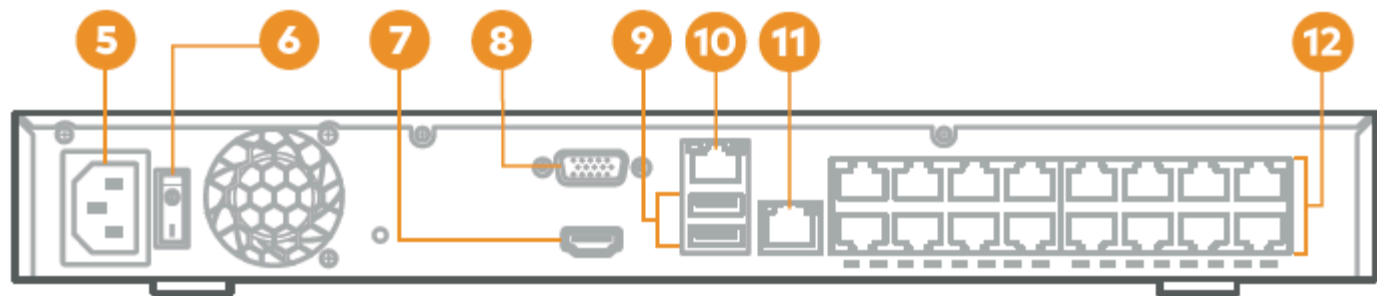
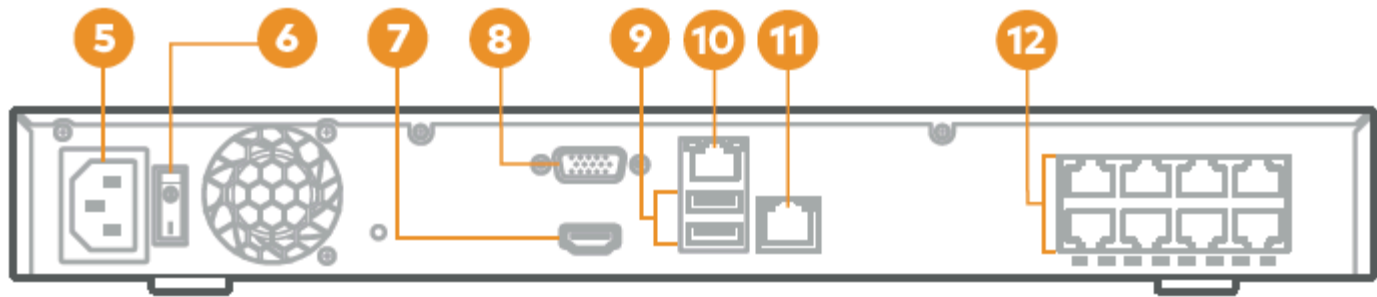

back (ADC-CSV2116P)

## Diagrama de rede recomendado para CSVR2108P/CSV2116P

### Router to CSVR Client port



\*The router must connect to the port labeled 'Client' on the back of the CSVR. Connecting the router to a port labeled "PoE" will cause a network loop and lead to failure of the local network.



### PoE Ports to Cameras



### Alarm.com Pro Series Camera

### Third Party Cameras

**Observação:** para otimizar o desempenho, Alarm.com recomenda o uso de nossas câmeras PoE Pro Series com o CSVR Pro Series.

## Como adicionar o dispositivo à conta Alarm.com

1. Use um cabo Ethernet para conectar o dispositivo à rede.
2. Se quiser usar um monitor com o seu CSVR Pro Series, conecte-o a uma das portas *HD Out* usando um cabo HDMI ou à porta *VGA* usando um cabo VGA.
3. Conecte o dispositivo a uma tomada aterrada exclusiva.
4. Para o CSVR2108P/CSV2116P: Use o interruptor na parte traseira do dispositivo para ligar o CSVR Pro Series.

5. Aguarde a inicialização do dispositivo. Um LED de status verde sólido indica que o dispositivo está pronto para ser adicionado à conta.

Para adicionar o dispositivo à conta customer account, use um dos seguintes métodos:

### **Método 1: Customer website** ^

1. Em um navegador, acesse: **www.alarm.com/addcamera**. Você precisará do nome de usuário e da senha do cliente para fazer login no site Customer website.
2. Selecione o CSVR Pro Series na lista de dispositivos de vídeo ou insira o endereço MAC para iniciar a adição do dispositivo. O endereço MAC do dispositivo encontra-se na parte inferior ou na embalagem.
3. Siga as instruções que aparecem na tela para finalizar a adição do CSVR Pro Series.

### **Método 2: MobileTech app** ^

1. Faça login no app MobileTech app.
2. Localize a customer account.
3. Toque para expandir **Ações rápidas**.
4. Toque em **Adicionar dispositivo**.
5. Toque em **Vídeo**.
6. Siga as instruções que aparecem na tela para finalizar a adição do CSVR Pro Series.

Você pode associar câmeras ao dispositivo e configurar unidades e monitores no site Customer website ou no app MobileTech app.

## **Montagem do dispositivo em rack**

O CSVR2108P/CSV2116P pode ser montado em um rack de servidor padrão usando o kit de montagem em rack fornecido. As montagens em rack foram projetadas para caber em uma área de 1U (unidade de rack).

O kit inclui os parafusos necessários para fixar o suporte para montagem em rack no dispositivo, mas não inclui os parafusos necessários para montar o dispositivo em um rack.

1. Remova com cuidado as sapatas de borracha da parte inferior do dispositivo.

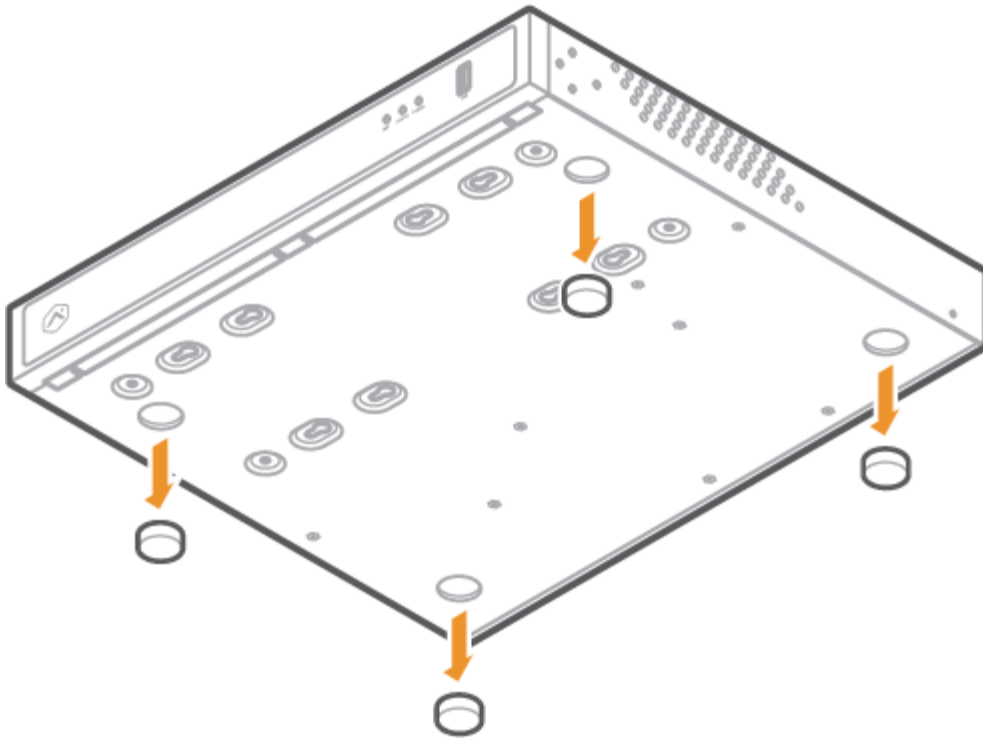

2. Usando os parafusos e suportes fornecidos, prenda um suporte em cada lado do dispositivo.

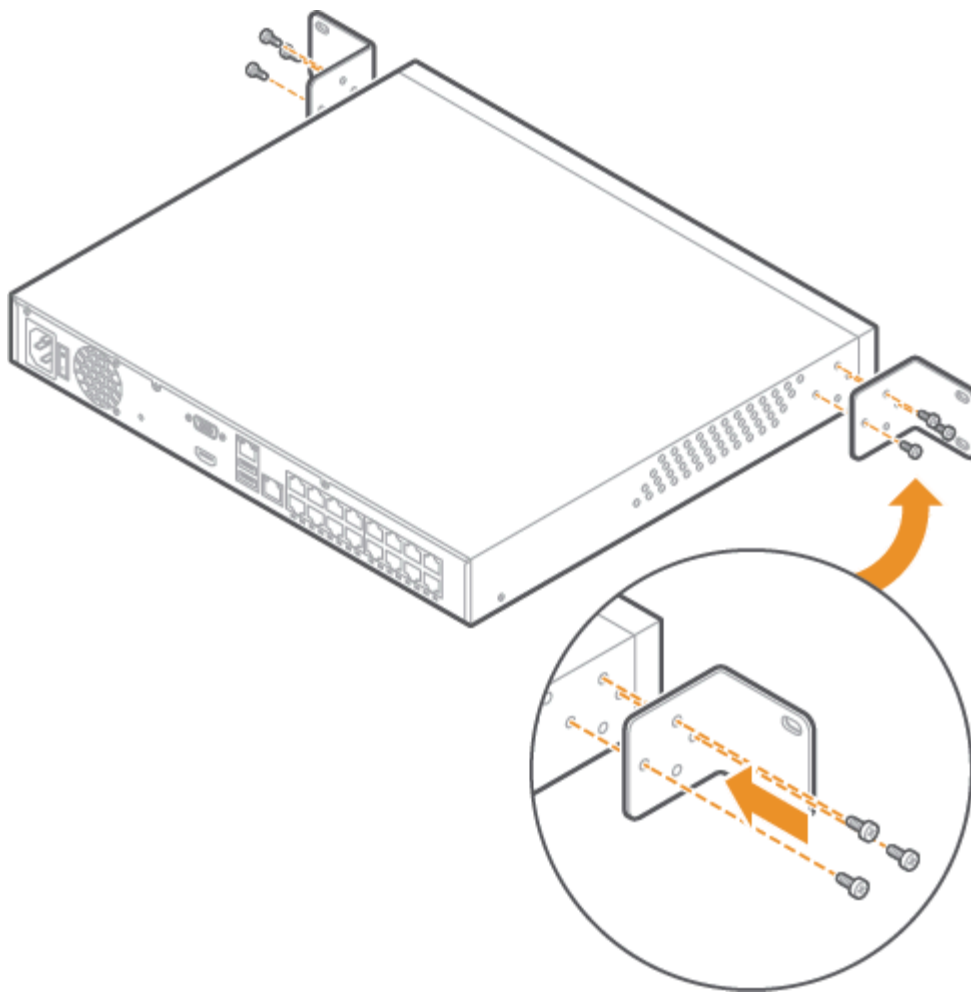

3. Usando parafusos para rack de servidor (não fornecido), prenda os suportes em cada lado do rack de servidor.



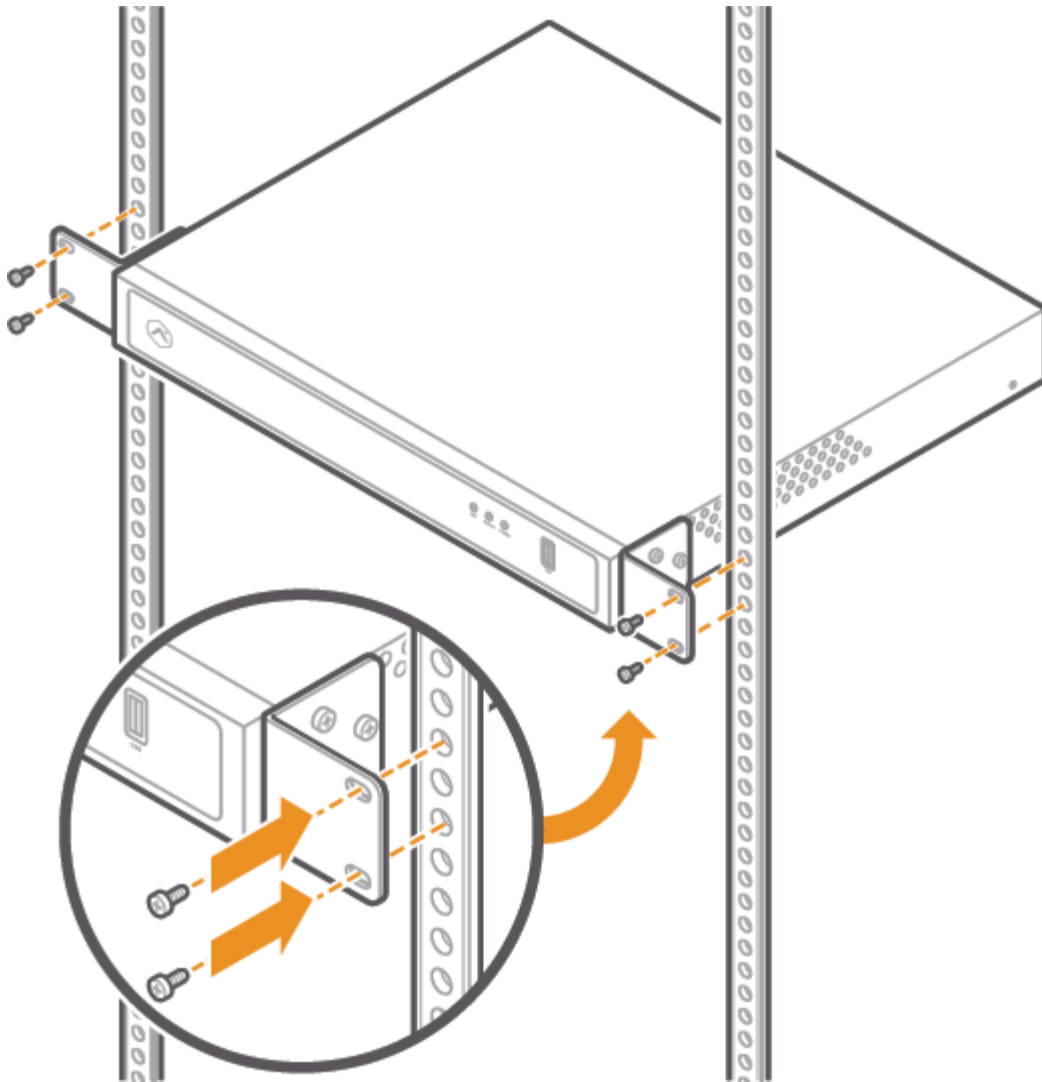





4. Verifique se há pelo menos 25 cm (10 pol.) de espaço livre atrás do dispositivo para garantir o fluxo de ar adequado.

## Legenda dos LEDs



## LED de rede

Padrão do LED	Descrição
<p>Pisca em verde</p> 	<p>Uplink do cliente ativo</p>
<p>Permanece apagado</p> 	<p>Uplink do cliente inativo</p>

## LED de alimentação

Padrão do LED	Descrição
<p>Permanece aceso em verde</p> 	<p>Ligado</p>
<p>Permanece apagado</p> 	<p>Inicializando ou desligado</p>

## LED de status

Padrão do LED	Descrição
Permanece aceso em verde 	Conexão a Alarm.com
Pisca em verde 	Conexão à rede local
Permanece aceso em vermelho 	Sem conexão
Permanece apagado 	Inicializando ou desligado

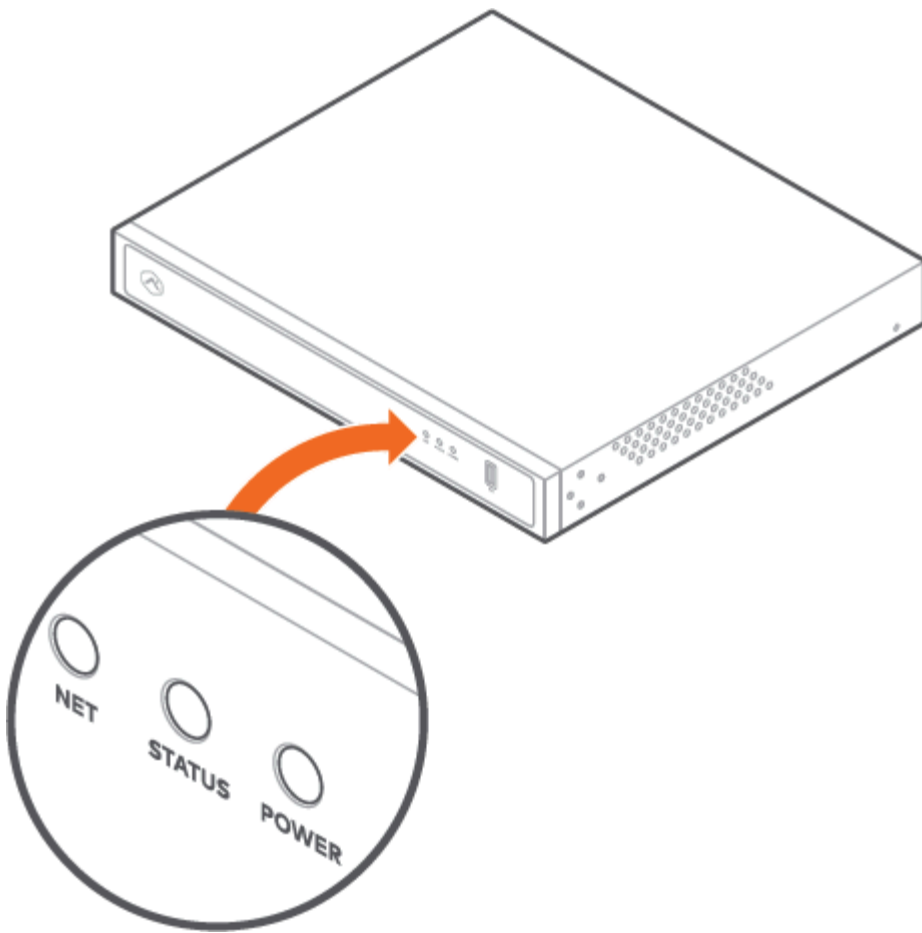

## Avisos

**Observação:** Os testes determinam que esse equipamento está em conformidade com os limites de dispositivo digital de Classe A, conforme a Parte 15 das regras da FCC. Esses limites têm a finalidade de proporcionar proteção razoável contra interferência nociva em instalações comerciais. Esse equipamento gera, usa e pode emitir radiofrequência. Por isso, caso não seja instalado conforme as instruções, pode causar interferência nociva às comunicações por rádio. A operação deste equipamento em área residencial pode causar interferências prejudiciais. Nesse caso, o usuário deverá corrigir a interferência às suas próprias custas.

Classificação:

- ADC-CSVR2108P – 100-240 VCA, 60-50 Hz, 3,5 A, 190 W
- ADC-CSVR2116P – 100-240 VCA, 60-50 Hz, 6-3 A, 280 W

O CSVR deve ser conectada apenas a redes PoE sem roteamento para instalações externas. Certifique-se de que todos os trabalhos de manutenção e reparo sejam executados por pessoal qualificado, como engenheiros eletricitas ou especialistas de rede. Conecte o sistema a uma tomada elétrica aterrada.

**Cuidado:** O uso de baterias incompatíveis pode causar explosão. Siga as instruções de descarte para baterias usadas.

**Importante:** A alimentação total destinada às portas POE do ADC-CSVR2108P é de 120 W; para as portas POE do ADC-CSVR2116P, esse total é de 200 W.

A saída máxima para cada porta é 30 W. Caso um dispositivo PoE consuma mais de 30 W, a alimentação PoE será desabilitada na porta utilizada.

Alterações ou modificações sem aprovação expressa da parte responsável pela conformidade podem resultar na proibição de operação desse equipamento por parte do usuário.