

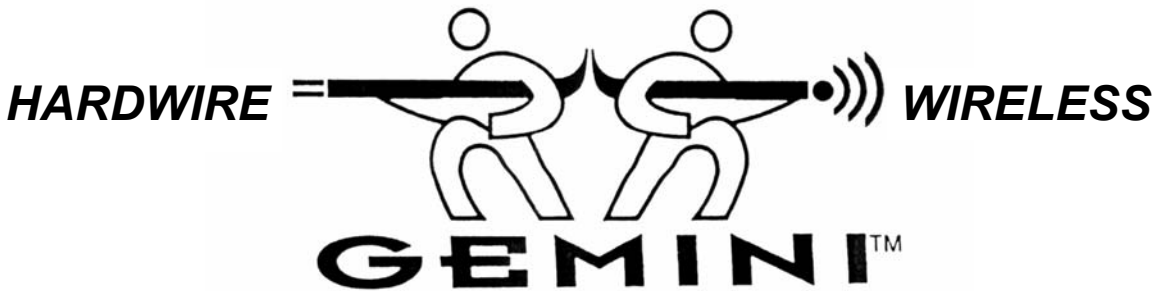

INSTALLATION INSTRUCTIONS

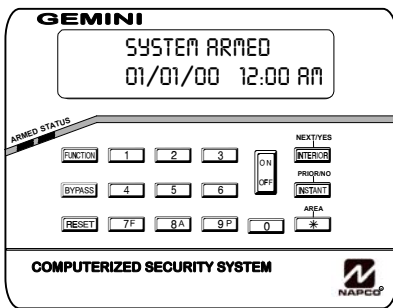

GEM-P9600 CONTROL PANEL/COMMUNICATOR



GEM-RP1CAe2

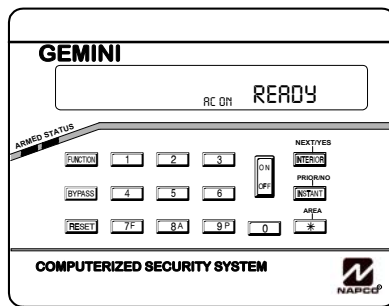

GEM-RP2ASe2

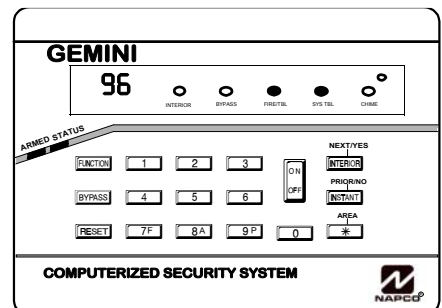

GEM-RP3DGTL

**THIS MANUAL INCLUDES FEATURES WHICH ARE ONLY AVAILABLE IN CONTROL PANEL
FIRMWARE VERSION 20 OR LATER.**

CHANGES FROM PREVIOUS EDITION

The following changes have been made to this manual (WI742C) since the last edition (WI742B).

New GEM-P9600 Version 20 Features:

- ✓ New Easy Programming Mode allows the system to be completely programmed through Menu Driven Easy Program Mode. Requires the use of the following version keypads:
 - GEM-RP1CAe2, Version 6
 - GEM-RP2ASe2, Version 5b
 - GEM-RP3DGTL, Version 1C
- ✓ Chime 2 zone provides second distinct pulsating "Chime Zone" tone
- ✓ Set System Time and Date in User Program Mode
- ✓ System Trouble Audible Automatic Timeout
- ✓ Inhibit System Trouble Audible
- ✓ Easy Programming of PC Preset Auto download ID and Callback Numbers
- ✓ Support of GEM-PRINT module
- ✓ Cancel Reporting Code
- ✓ Wireless Trouble Reporting by Zone
- ✓ Pager (Telco 3) Reporting Delay
- ✓ Pager - Programmable Number of Reports of Same Signal
- ✓ Pager - Maximum Number of Consecutive Pages
- ✓ Specific Logging of Communication Failure Modes
- ✓ New Relay Event "Area Disarmed" (PCD3000 programmable only)
- ✓ Programmable DST start date (PCD3000 programmable only)
- ✓ 20 Digit Dialing Prefix

Upon entering program mode, the keypad display will flash the control panel firmware version, followed by the keypad firmware version:
GEM-RP1CAe2: [2006], GEM-RP2ASe2: [205b], GEM-RP3DGTL: [20/1C]

NOTE: Typically, any version GEM-P9600 control panel could be upgraded to the latest firmware by replacing the EPROM with a newer version. This is no longer the case. The Firmware Version 20 EPROM must only be used in a Version 18 (or greater) PCBoard. Do NOT attempt to upgrade a GEM-P9600 control panel which currently is running Firmware Version 11C (or prior) to version 20 (or greater) by replacing the EPROM.

The PCBoard version (triangle number) is printed on a triangular shaped sticker affixed to the GEM-P9600 circuit board.



NAPCO Security Systems, Inc.
333 Bayview Avenue, Amityville, New York 11701
For Sales and Repairs, call toll free: (800) 645-9445
For direct line to Technical Service, call toll free: (800) 645-9440
Internet: <http://www.napcosecurity.com>

TABLE OF CONTENTS

INTRODUCTION.....	4	STANDBY-BATTERY CALCULATION WORKSHEET ...	53
<i>General Description</i>	4	WIRING LEGEND	54
<i>Features.....</i>	4	KEYPAD PROGRAMMING MODES	55
<i>Specifications.....</i>	6	GEM-P9600 WIRING DIAGRAM	61
<i>Ordering Information.....</i>	6	STATEMENT FOR CANADIAN MODELS (DOC)	52
<i>Summary of UL Requirements.....</i>	8	FCC STATEMENT	63
INSTALLATION.....	9	LIMITED WARRANTY	64
<i>Mounting</i>	9		
<i>Wiring.....</i>	10		
<i>Wireless Systems</i>	10		
<i>Typical Residential Fire Installation</i>	10		
<i>Typical Partitioned Installation</i>	10		
<i>UL Commercial-Burglary Installations.....</i>	11		
<i>Testing the System</i>	12		
WIRING CONNECTIONS	13		
<i>Battery.....</i>	13		
<i>Transformer</i>	13		
<i>Siren/Bell Output.....</i>	13		
<i>Auxiliary Alarm Output.....</i>	13		
<i>PGM Outputs</i>	13		
<i>Remote Bus</i>	14		
<i>Earth Ground</i>	14		
<i>Auxiliary Power</i>	14		
<i>Reset Output.....</i>	15		
<i>Basic Zone Configuration.....</i>	15		
<i>Expanded Zone Configuration</i>	15		
<i>4-Wire Smoke Detectors.....</i>	16		
<i>2-Wire Smoke Detectors.....</i>	16		
<i>Telephone Lines</i>	17		
KEYPAD CONFIGURATION MODE	18		
<i>Keypad Installation.....</i>	18		
<i>Configuring the Keypads.....</i>	18		
BASIC OPERATION.....	21		
<i>User Codes & Zone Descriptions.....</i>	21		
<i>Arming and Disarming the System</i>	22		
<i>Bypassing Zones</i>	24		
<i>Alarm Indication</i>	24		
<i>Function Mode</i>	25		
<i>Keypad Messages</i>	30		
GLOSSARY	31		

Refer to accompanying GEM-P9600 Programming Instructions (WI777) for programming information.

NOTE: THESE INSTRUCTIONS ARE INTENDED AND WRITTEN FOR PROFESSIONAL INSTALLATION PERSONNEL HAVING SUITABLE TRAINING, EXPERIENCE AND INSTALLATION EQUIPMENT. IT IS RECOMMENDED THAT AFTER PROGRAMMING, THE ERROR CHECK UTILITY OF THE PCD3000 DOWNLOADER BE USED TO VERIFY THAT THE CONTROL PANEL PROGRAM CONTAINS NO ERRORS OR CONFLICTS WHICH MAY INHIBIT ITS INTENDED OPERATION.



INTRODUCTION

GENERAL DESCRIPTION

NAPCO's Gemini GEM-P9600 is a state-of-the-art microcomputer-based burglary and residential fire alarm control panel of modular design. Integrally an 8-zone panel, it will support up to 96 zones with optional zone expansion modules, wireless receiver modules and/or GEM-RP1CAe2 Keypads. Each panel includes an integral digital communicator.

The control panel features programmable area partitioning. That is, the system may be divided into up to two discrete multiple-zone areas, each allowing access by only those users programmed for their respective area.

Opening Suppression and Closing Suppression, available through Napco Quickloader software, suppress reporting within programmed "windows". Conversely, Exception Reporting can transmit a "fail to close" if the panel is not armed within programmed intervals and, similarly, a "fail to open" if the panel is not disarmed within programmed intervals. Furthermore, the panel can be programmed to automatically arm either area at any time. A log containing up to 800 events (accessible through Quickloader™ software) monitors control-panel activity referenced to a precision real-time clock. A detailed event history may be displayed at the computer, using NAPCO's PCD3000 Quickloader Software.

Keypads feature a liquid-crystal display for messages. In normal use, the LCD shows zone identification and status messages. Conventional LEDs and a sounder are also provided for annunciation.

Data may be quickly and easily downloaded to the control panel using a PC-compatible computer with NAPCO's PCD3000 Quickloader software and PCI2000 computer interface. Or, the panel may be programmed using the keypad in its secondary mode of operation. In the keypad programming modes (there are two: Dealer and User), the LCD shows memory address, data values, programming prompts, and the alphanumeric characters required for entering up to 32 user codes and custom zone descriptions.

GEM-P9600M

The standard GEM-P9600 may be converted to the Mercantile "GEM-P9600M" version with the optional accessory, H1217. The H1217 kit includes the model H217 heavy-duty UL commercial enclosure, the required (2) tamper switches and required tamper screws.

Note: Do not use Fire Zones in a Mercantile installation.

NOTE: Failure to install and program as described in this manual for UL-listed systems voids the listing mark of Underwriters Laboratories, Inc.

FEATURES

Control Panel Features

- ✓ Eight end-of-line-resistor burglary zones programmable for Area, Exit/Entry Delay, Interior, Follower, Day Zone, Chime, Fire options, Sensor Watch, Swinger Shutdown, Zone Anding and a variety of other features.
- ✓ Supports up to 96 zones with optional zone-expansion modules and 4-zone keypads.
- ✓ Supports up to 96 individually coded users, each with a programmable authority level.
- ✓ Supports three on-board relay outputs and up to 96 external relay outputs.
- ✓ Supports three keypad panics: Fire, Police & Auxiliary
- ✓ Supports up to 8 independent area partitions.
- ✓ Supports up to 8 separate access stations by up to 96 users.
- ✓ Supports up to 64 separately-addressable X-10 devices with the GEM-X10KIT and PC04 interfaces.
- ✓ English-language prompts & system status messages.
- ✓ User-customized zone descriptions, re-programmable as required.
- ✓ Supports 2-wire and 4-wire smoke detectors.
- ✓ Reports alarms, restores and troubles by zone.
- ✓ 255 Event Schedule

- ✓ 800 Event Log.
- ✓ Overview Mode permits monitoring and control of total system from one keypad.
- ✓ Guard-Tour programmable for start time, tour length, and check points (tour stations).
- ✓ Two programmable entry delay times.
- ✓ Two Interior-Zone groups.
- ✓ Dynamic battery test interrupts charging and places battery under load every four hours.
- ✓ Chime by zone; programmable duration.
- ✓ Non-volatile RAM retains memory during power losses.
- ✓ Quickloader programmable.
- ✓ Auto-Download Log.
- ✓ Exclusive V.A.L.I.D. feature (Verifying Automatic Line-Integrity Diagnostic) reduces false alarms due to changes in line resistance.

Communicator Features

- ✓ Compatible with all major receiver formats, including BFSK, 4/2, Modem 2, SIA, 4/3/1, 4+2 Express and Point ID.
- ✓ Rotary dial and TouchTone™ with Rotary backup.
- ✓ Three 20-digit telephone numbers.
- ✓ Backup Reporting; Double Reporting; Split Reporting.
- ✓ 96 User Codes with Opening/Closing Reporting by user.
- ✓ Ac Failure Reporting with programmable report delay.
- ✓ Supervised telephone line with programmable delay.
- ✓ Pager capability.

Keypad Features

- ✓ English-language LCD display; LED and sounder annunciators.
- ✓ Supports up to 15 4-wire keypads.
- ✓ Access only capability.
- ✓ Provisions for fire, police and auxiliary panic alarms.
- ✓ Integral 4-zone EZM included in each keypad (GEM-RP1CAe2 only).
- ✓ Communicator Test to Central facilitates testing; Locate, Fault-Find and EZM-Locate diagnostics simplify troubleshooting.
- ✓ PGM output.

SPECIFICATIONS

GEM-P9600

Panel Dimensions: 12.375" x 13.875" x 3.55" (H x W x D)

Operating Temperature: 0-49°C (32-120°F)

Input Power: 16.5VAC via CLASS 2 Plug-In 40VA or 50VA Transformer

Loop Voltage: 10-13Vdc

Loop Current: 2.4mA with 2.2K Ohm end-of-line resistor (Model EOL2.2K); 5mA for 2-wire smoke-detector zones; 1.4 mA using a 3.9K Ohm resistor (Model EOL 3.9K) with Zone Doubling

Loop Resistance: 300W max.; 50W for 2-wire smoke-detector zones

Relay Outputs (Burglary; Reset; Aux): Wet, 12Vdc, 1.2A max.; Dry (cut related jumper for dry contacts; see Wiring Diagram), SPDT contacts 24Vdc, 2A, 0.6 PF

Auxiliary Power Output: 12Vdc regulated

Remote Power Output: 12Vdc regulated (for keypads)

Combined Standby Current (Remote Power + Aux. Power + Reset Relay Power): See following charts.

RESIDENTIAL BURGLARY & COMMERCIAL BURGLARY						
TRANSFORMER	RECHARGEABLE BATTERY	POWER SUPPLY	GEM-P9600 COMBINED STANDBY CURRENT	GEM-P9600 ALARM CURRENT	POWER SUPPLY STANDBY CURRENT	STANDBY TIME
TRF11 (16.5 VAC, 40 VA)	RBAT4 (12 VDC, 4 AH)	N/A	750 mA	2.0 A	N/A	4 Hours
TRF11 (16.5 VAC, 40 VA)	RBAT6 (12 VDC, 6 AH)	N/A	750 mA	2.0 A	N/A	6 Hours
TRF11 (16.5 VAC, 40 VA) ⁽³⁾	RBAT6 (12 VDC, 6 AH)	PS3002 (13.2 VDC, 1.9 A)	750 mA ⁽¹⁾	1.9 A ⁽²⁾	1.2 A ^(1,2)	4 Hours
TRF11 (16.5 VAC, 40 VA) ⁽³⁾	2 RBAT6 (12 VDC, 6 AH)	PS3002 (13.2 VDC, 1.9 A)	750 mA	1.9 A	1.4 A	4 Hours

RESIDENTIAL FIRE, COMBINATION RESIDENTIAL FIRE & BURGLARY				
TRANSFORMER	RECHARGEABLE BATTERY	GEM-P9600 COMBINED STANDBY CURRENT	GEM-P9600 ALARM CURRENT	STANDBY TIME
TRF11 (16.5 VAC, 40 VA)	RBAT7 (12 VDC, 7 AH)	150 mA	650 mA	24 Hours

Note: ⁽¹⁾ With 1 RBAT6 battery, GEM-P9600 combined standby current + PS3002 standby current may not exceed 1.2A.

⁽²⁾ W(2) With 2 RBAT6 batteries, GEM-P9600 combined standby current + alarm current may not exceed 1.9A

⁽³⁾ Not evaluated by U.L.

Standby Time: Residential Fire/Burglary & Commercial Burglary, 4 hours minimum

EZM Module: GEM-EZM8: Input, 50mA (not including PGM output)

PGM Output: 5mA, 12V Special Application

Keypad Current: GEM-RP1CAe2: 100mA; 35mA if backlighting is disabled (cut W1, W2 & W3)

GEM-RP2ASe2: 50 mA

GEM-RP3DGTL: 50 mA

PGM Output: 5mA, 12V Special Application

Maximum Number of Keypads: 15

Maximum Wiring Length for each run (#22AWG): 1000' divided by total number of keypads and EZMs on run

Keypad Dimensions: 4" x 5" x 1" (H x W x D); 11.1cm

ORDERING INFORMATION

System Components

GEM-P9600: Residential UL-Listed Burg Control Panel.

GEM-RP1CAe2: 32-Character LCD Burg & Residential Fire Keypad with 4 EOL Zones.

GEM-RP2ASe2: LCD Burg & Residential Fire Keypad with remote panic.

GEM-RP3DGTL: Digital Burg and Residential Fire Keypad with remote panic.

Optional Accessories and Peripherals

EOL130: 2-Wire Fire Zone Resistor, 130W, 3W
EOL2.2K: End-of-Line Resistor Assy., 2.2K for Fire Circuit
FT2200: End-of-Line Relay/Resistor Supervisory Module
GEM-DT: Wireless Dual-Technology Sensor **
GEM-EVA 1: Electronic Voice Annunciator *
GEM-EZM4: 4-Zone Expansion Zone Module
GEM-EZM8: 8-Zone Expansion Zone Module **
GEM-GB: Wireless Glass-Break Detector **
GEM-KEYF: Key Fob Transmitter **
GEM-HEAT Wireless Heat Detector **
GEM-PIR: Wireless PIR **
GEM-PRINT: Parallel Printer Interface *
GEM-RECV8: Wireless Receiver, 8 Zones **
GEM-RECV16: Wireless Receiver, 16 Zones **
GEM-RECV96: Wireless Receiver, 96 Zones **
GEM-RS232KIT: Home Automation Interface *
GEM-SMK: Wireless Smoke Detector **
GEM-TRANS2: Window/Door Transmitter, 2-Point **
GEM-WP: Waterproof Panic Transmitter **
GEM-X10KIT: X-10 Interface *
H1217: Mercantile Conversion Kit
PCD3000: Downloading Software for IBM PC-Compatible
PCI2000/3000: Software with Interface for IBM PC-Compatible Computer
PCI-MINI: Notebook Computer Interface *
PS3002: Power-Supply Module, 13.2Vdc, 1.9A
RB1000: Relay Board *
RBAT4: Rechargeable Battery, 12Vdc, 4AH
RBAT6: Rechargeable Battery, 12Vdc, 6AH
RBAT7: Rechargeable Battery, 12 VDC, 7AH
RBATH1: Dual Battery Harness *
RM3008: Relay Module (in enclosure)
RPB-3: Universal Junction Box
TRF11: Transformer, 16Vac/40VA, Class 2
TRF14: Transformer, 16Vac/50VA, Class 2
WIZARD IIe: Telephone Interface Module *
WL1: Wire Assembly with Lug Connector, 20"
VERI-PHONE: Two-Way Voice/Listen-In Module *
W834-1: Keypad Cable, plug-in (20")

OI163: Instruction Manual, GEM-P9600
OI192: Instruction Manual, GEM-RP2ASe2
OI193: Instruction Manual, GEM-RP1CAe2
OI249: Instruction Manual, GEM-RP3DGTL
WI777: GEM-P9600 Programming Manual

* Not investigated by UL.

** Not investigated by UL for commercial applications.

UL LISTINGS

Household Burglar Alarm System Units: UL1023
 Household Fire Warning System Units: UL985
 Local Burglar Alarm Units and Systems: UL609
 Central Station Burglar Alarm Units: UL1610
 Police Station Alarm Units: UL365

COMPATIBLE UL-LISTED DEVICES

Refer to the following list of recommended devices.

Bells:

Ademco AD8-12; AD10-12
 Amseco MBL-8/12V; MBL-10/12V
 Wheelock 46T-G4-12-R*; 46T-G6-12-R; 46T-G10-12-R
 Hochiki America AL-VB-1012*; AL-MB-612*
 *Not for Household Fire applications (<85dB at 10')

Grade-A Bell:

Ademco AB-12 Bell in Box

Horns:

Wheelock 34T-12-R; MT-12/24; MT4-12/24; MIZ-12
 Faraday 6120-0-0-12-DC*
 Federal Signal 450E-24
 Hochiki America AL-FH-12M*
 *Not for Household Fire applications (<85dB at 10')

Mini-Horn:

Federal Signal 460-024-R (red); -W (white); -BG (beige)

Chimes:

Wheelock CH-CF1-12; CH-DF1-12 (both for private-mode signalling only)

Strobes:

System Sensor SS1215ADA; SS1215ADAB
 Wheelock LS12

Strobe/Horns:

Wheelock 7002T-12-W-FR; 7001T-12-W-FR; V7001T-12-W-FR
 Gentex SHG-12H
 System Sensor MASS1215ADA; MASS1215ADAB

Electronic Signals:

Wheelock ES-BH2-R; ES-DL2-R; ES-EL2-R

Electronic Signal/Strobes:

Wheelock ES-BH2-WH-12DC-HF-R; ES-DL2-WS-12DC-VF-R; ES-EL2-WS-12DC-HF-R

Bell/Strobes:

Wheelock 46T-G6-12-WS-12-HF-R; 46T-G10-12-WS-12-HF-R

Transformers:

Basler Electric BE116240CAA 40VA; BE116250CAA 50 VA



Compatible Smoke Detectors

UL Compatible Smoke Detectors (Providing UL Recognition or Listing)					
4 Wire Smoke Detectors			2 Wire Smoke Detectors		
Manufacturer	Model	Base	Manufacturer	Model	Base
Gentex	812, 812T, 812P,	N/A	NAPCO	FW-2	N/A
	812PT, 812PH,	N/A	Sentrol/ESL	711U, 712U,	701U, 702U,
	8120, 8120T,	N/A		721U, 721UT,	702RE, 702RU
	8120P,	N/A		722U, 731U, 732U	
	8120PTY, 8120-PH	N/A	System Sensor	1100, 1151,	N/A
Hochiki	SLG-12 w/YBC-RL4-RA base	N/A		1400, 2100,	N/A
NAPCO	FW-4	N/A		2100T, 2100S,	N/A
Sentrol/ESL	445AT, 445C,	N/A		2100TS, 2151,	N/A
	445CT, 445CR,	N/A	2400, 2400TH	N/A	
	445CRT	N/A	Note: Voltage Rating: 8.5-13.3 VDC Maximum Number of Detectors: 10		
System Sensor	1112, 2112,	N/A			
	21112T, 211TSRB	N/A			
	1412TH, 2412TH	N/A			
	2312/24T, 1412,	N/A			
Note: Subtract total smoke-detector alarm current from available standby current.					

Note: Any normally-open devices that do not require power from the control panel, such as pull stations, waterflow and thermostats may be used if acceptable to the Authority having Jurisdiction.

SUMMARY OF UL REQUIREMENTS

Residential

- ✓ Recognized Limited-Energy Cable for initiating, indicating and supplementary circuits.
- ✓ Initiating loops supervised if longer than 3 feet
- ✓ FT2200 End-of-Line Relay for Fire (if using 4-wire smoke detectors)
- ✓ Minimum alarm timeout of 5 minutes
- ✓ Maximum exit time: 60 seconds
- ✓ Maximum entry time: 45 seconds
- ✓ Do not program “Swinger Shutdown”, “Force Arming”, “Selective Bypass”, “Group Bypass”, or “50 ms Loop Response”
- ✓ “Abort Delay” may not exceed 45 seconds
- ✓ Program “Disable Callback Download”
- ✓ Automatic dialer may not dial a police station number that has not been dedicated for such service
- ✓ System must be tested at least weekly under AC/battery and Battery-Only conditions
- ✓ Replace the rechargeable battery at least every 5 years
- ✓ If the battery is heavily discharged, replace it or have it tested by a qualified technician
- ✓ For silent panic, connect only to UL-listed holdup devices
- ✓ All zones must be programmed for “Priority”
- ✓ Do not program any zones for “Keyswitch Arming”

INSTALLATION

CAUTION: This equipment generates and uses radio-frequency energy. If not installed using conventional installation practices for RF devices, it may cause interference to radio and television reception. It has been tested and found to comply with the limits for a Class A computing device pursuant to Subpart B of Part 15 of FCC Rules, which are designed to provide reasonable protection against such interference. However, there is no guarantee that interference will not occur in a particular installation. If it has been found to cause interference to radio or television reception, which can be determined by removing and reapplying AC and battery power to the equipment, the installer should try to correct the interference by one or more of the following measures: reorient the receiving antenna; connect the power transformer to a different outlet so that the control panel and receiver are on different branch circuits; relocate the control panel with respect to the receiver.

MOUNTING

Control Panel

Choose a mounting location accessible to (a) a continuously-powered AC source, (b) system ground, a steel or copper ground rod, ideally no further away than 10 feet, and (c) telephone lines (keep telephone wiring away from keypad wires). Remove appropriate knockouts for cables. Place the control panel at a convenient viewing height and mark the mounting holes. Attach the enclosure using screws suitable for the mounting surface.

Grounding

Connect the control-panel grounding screw through a No. 16 AWG. or larger wire to a long steel or copper ground rod driven deeply into the earth. Do not use a gas pipe, plastic pipe or ac ground connections. Make the run as short and direct as possible, without any sharp bends in the wire.

Tamper Switches

Tamper switches may be installed to prevent opening of the control-panel door or removal of the cabinet from the wall. Ideally, tamper switches should be connected to a zone that is active at all times, thus it may be necessary to program that zone as a 24-Hour Zone or Day Zone. When used on a normally-open zone, normally-closed tamper switches (open when set) should be wired in parallel. On a normally-closed zone, install Napco TPS-2 normally-open tamper switches (closed when set) in series.

There are two places in the cabinet to mount tamper switches: (1) To prevent cabinet removal from the wall, there are three mounting holes on the left side of the cabinet, another hole on the back that allows the switch button to contact the wall. (2) To prevent opening the cabinet door, there are three mounting holes on the right side of the cabinet. When mounted, the switch button should contact the inside of the door. Be sure to alert the user that opening the enclosure door will cause a tamper alarm. **Note:** Each tamper switch is furnished with three machine screws for mounting, and one self-tapping screw. The sole purpose of the self-tapping screw is to tap the holes for the machine screws; it may be discarded after use.

Keypad

A keypad should be located near each exit/entry door. The keypad features a handy pull-up reference label. Before mounting the keypad onto the wall, push the Sliding Label Plate (with label and felt backing affixed and handle facing forward) down the guides at the rear of the keypad until it snaps into place. Once installed, the Sliding Label Plate cannot be removed without first removing the keypad from the wall. **Note:** (1) The keypad fire and panic keys should not be considered a substitute for a listed manual initiating device, such as a pull box. (2) Each GEM-RP1CAe2 includes provisions for four additional zones. See ADDING EXPANSION ZONES.

If installing onto a double-gang box, insert mounting screws through the two vertical elongated holes on the left side of the case and into the box. If the box is visible when viewed from the front, adjust the keypad vertically and tighten the screws. Then, using hardware suitable for the mounting surface, add one or two screws at the right side of the keypad case directly into the wall to ensure a secure installation. **Note:** Do not overtighten the screws! Uneven walls may cause the keypad case to distort.



WIRING

Wire keypad(s), zones, expansion zone modules and output devices as shown on the Wiring Diagram. Note that the Wiring Diagram contains important information not available elsewhere in this manual.

CAUTION: Do not run telephone wiring near speaker wires; do not run keypad wiring with loop wiring.

Adding Expansion Zones

GEM-P9600 Series control panels will handle up to 8 zones as is, however this number may be increased to as many as 96 programmable zones using optional expansion zone modules (EZMs).

WIRELESS SYSTEMS (NOT EVALUATED BY U.L.)

With the addition of at least one GEM-RECV series receiver, the GEM-P9600 will support up to 96 wireless transmitters. The panel can accommodate one to four receivers within the premises, responding to the one with the stronger transmitter signal. If any transmitters are selected for the default program, a GEM-RECV receiver will automatically be programmed.

The keypad can display the status of any transmitter, indicating the condition of the zone (normal or open) and transmitter troubles (low battery, tamper or supervisory failure), and signal strength of the last transmission. A receiver failure will be indicated by "E06-NN" ("no response", with NN representing the receiver number).

TYPICAL RESIDENTIAL FIRE INSTALLATION (WHERE PERMITTED BY LOCAL CODES)

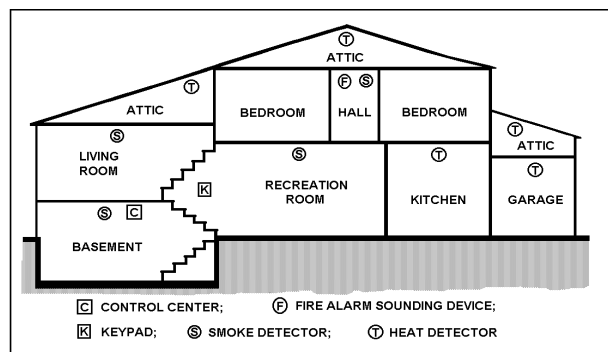

At least one smoke detector should be installed directly outside each sleeping area. If there is more than one floor, additional smoke detectors should be installed on each level, including the basement. The living-area and basement smoke detectors should be installed near the stairway of the next upper level. For increased protection, additional detectors should be installed in areas other than those required, such as the dining room, bedrooms, utility room, furnace room, and hallways. Heat detectors, rather than smoke detectors, are recommended in kitchens, attics, and garages due to conditions that may result in false alarms and improper operation. Large areas and areas with partitions, ceiling beams, doorways, and open joists will require additional detectors.

Refer to NFPA Standard No. 74 (National Fire Protection Association, Batterymarch Park, Quincy, MA 02269) for additional information, including proper mounting of detectors.

TYPICAL PARTITIONED INSTALLATION

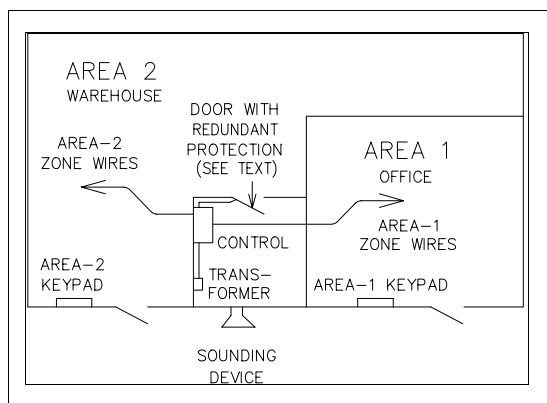

Described and illustrated here are an example of a partitioned system with common-area protection of the control-panel room. This system meets UL requirements for a partitioned installation.

- ☞ Both areas must be owned and managed by the same person(s).
- ☞ Both areas must be part of one building at one street address.
- ☞ The control panel and all wiring protecting each partitioned area must be confined to the respective area and may not encroach upon the other area. This requires that the control panel room have redundant protection; that is (a) multiple sets of door contacts, each wired to a separate zone and (b) one of those zones programmed for each area. In order to gain access to this protected area without causing an alarm, both partitions must be disarmed. In lieu of redundant protection, 24-Hour Zones may be used. Any zone protecting the control panel and transformer may not be programmed for bypass.
- ☞ The sounding device must be placed such that the bell test can be heard by all partitions. Note: NFPA 74 (Household Fire Warning Equipment) requires that

a fire alarm audible device be installed indoors.

- ☞ The User Program Code is not to be given to anyone except the authority responsible for all partitions.

UL COMMERCIAL-BURGLARY INSTALLATIONS (PENDING)

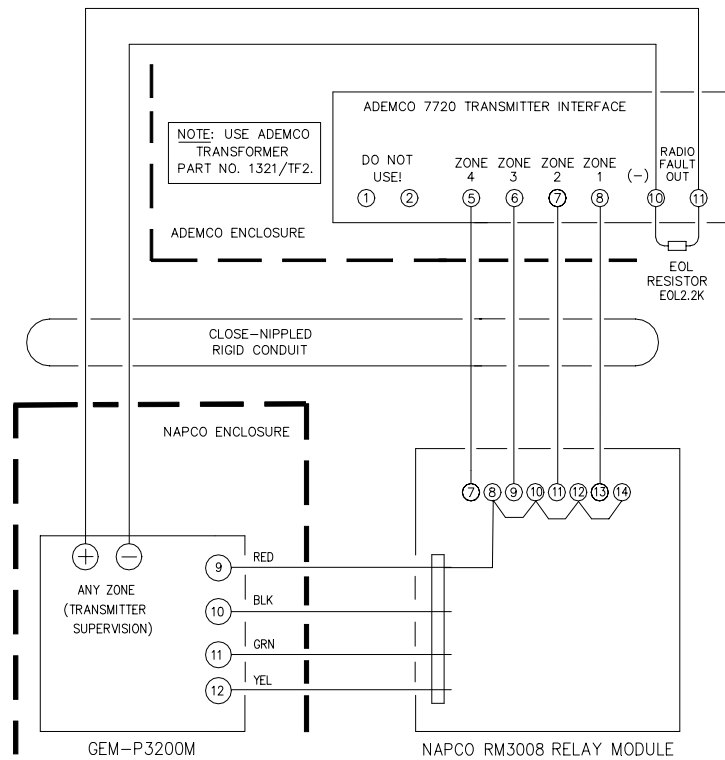

- ✓ Low-Battery Annunciation.
- ✓ An Ademco AB-12 Bell and Box (12-volt).
- ✓ Program Auto Bell Test on Arming.
- ✓ a maximum Entrance and Exit Delay of 60 seconds.

Interfacing to the Ademco 7720 Long-Range Wireless System

The RM3008 may be used to interface the GEM-P9600M control panel to the Ademco 7720 transmitter in order to meet UL Central Station Grade-A or Grade-B requirements by using a digital communicator combined with one-way wireless. (Normally, a digital communicator is Grade C, and may be Grade B if the specified Grade-A local bell is used.) Refer to the wiring diagram which follows, and to the instructions furnished with the Napco and Ademco equipment for further information concerning the DACT, listed compatible receiver and formats, Grade-A local bell and bell housing. Enable Line Fault Test must be programmed.

Central Station Grade-B Requirements (Pending)

Wiring to the Ademco 7720 transmitter must be enclosed in rigid conduit when outside walls, or in flexible conduit when inside walls or above ceilings, for the entire length up to the transmitter room. The transmitter room must be protected by a UL listed intrusion detection unit that is connected to one of the input channels of the Ademco 7720. Relays must be programmed to trip the Ademco 7720 for alarms on all protective circuits, including tampers, telco phone failure, 24-hour test timer, transmitter low battery and ac loss. (See PCD3000 External Relay Control screen.) One zone on the GEM-P9600M, programmed as a 24-Hour Zone, must supervise the radio.

Central Station Grade-A Requirements (Pending)

In addition to Grade-B Requirements (above), one relay on the RM3008 must be programmed to trip the Ademco 7720 when the telephone line fails. Daily openings and closings are required to be transmitted by the Napco panel along with the 24-hour DACT test signal and DACT trouble conditions.

The GEM-P9600M can be used as part of a UL Central Station Grade C, B, or A installation. Normally, a digital communicator is classified as Grade C and may be classified Grade B if used with the specified Grade-A Local bell and bell housing. A UL Central Station Grade-A installation requires the use of a Napco RM3008 Relay Board and Ademco 7720 Radio System. Refer to the installation instructions furnished with each component for respective installation requirements.

For a UL Commercial Grade-A Police Station Connection, refer to GRADE-A LOCAL MERCANTILE INSTALLATIONS, which follows. Use the M278 Line-Reversal Monitor to provide basic line security; refer to the instructions accompanying the M278 for other installation requirements.

For UL Commercial safe and vault applications, use a UL-listed shock sensor suitable for metal enclosures. Install tamper switches on front and rear of control-panel enclosure.

Grade-A Local Mercantile Installations

A Grade-A Local Mercantile installation must use at least a 6.0AH standby battery. Programming must include Auto Bell Test on Arming. Trouble on Night Open may not be programmed for any zone.

The minimum requirements for a listed Grade-A Local system include:

TESTING THE SYSTEM

After installation is completed, test the system as follows.

1. Call the central station to inform them of the test.
2. Initiate an alarm, preferably on a zone that activates a steady siren, and verify proper signaling.
3. Wait 5 minutes.
4. Call the central station to confirm their receipt of a good transmission.

Note: Be sure to test all enabled keypad panics.

Signal Strength Testing/Wireless Systems

To test the operation of wireless transmitters, proceed as follows. (**Note:** Wireless systems have not been investigated by UL.)

1. Fault a point of each transmitter to be tested by faulting the zone.

The transmitter signal strength can be displayed using the DISPLAY RF XMITTER STAT function. Enter a Level 3 User Code or enter the Dealer Code, press the **FUNCTION** button and answer NO until "DISPLAY RF XMITTER STAT" is displayed. Press YES (**INTERIOR** button) and the Wireless Signal Strength of the wireless zone will be displayed. The Wireless Signal Strength will be displayed from 1 to 10 with 10 being the strongest signal and any signal under 3 as unacceptable. Except in the Fault-Find Mode, signal strengths less than 3 will be entered into the system log. Press NEXT (**INTERIOR** button) to step the next zone.

The last received signal strength for each transmission is always stored in memory and can viewed at any time using this procedure. Signal strength can also be viewed through the PCD3000 Status Screen.

WIRING CONNECTIONS

BATTERY

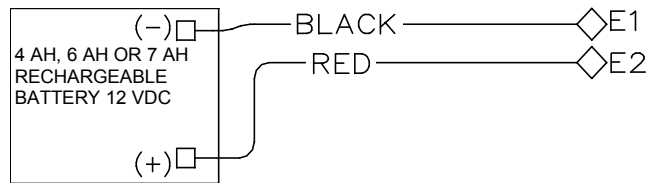

The RED (+) and BLACK (-) flying leads must be connected to a 12VDC 4, 6 or 7 AH Rechargeable Battery, to serve as backup power in the event of AC Power Failure. **NOTE:** To calculate the available standby time refer to the Standby-Battery Calculation Worksheet at the back of this manual.

TRANSFORMER

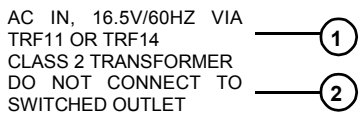

Connect a 16.5 VAC Transformer to Terminals 1 and 2, using a wire of #18 AWG. or less at a distance of 15 ft. or less from the control panel. **NOTE:** Do not connect to a switched outlet.

SIREN/BELL BURG/FIRE ALARM OUTPUT

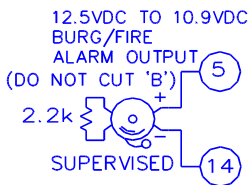

Connect the alarm sounding devices (self-contained sirens, speakers or a mechanical bells) to terminals 5 (+) and 14 (-). Any self-contained siren requiring a 12 VDC input can be connected. When connecting a mechanical bell, it must be supervised using a 2.2k Ohm resistor. To connect 8 Ohm Speakers use a Siren Driver with the proper polarity observed. **NOTE:** Refer to the Wiring Diagram for alarm current specification, bell supervision and burglary output relay.

AUXILIARY ALARM OUTPUT



Auxiliary Output can be activated depending on the programming options selected (see GEM-P9600 Programming Instructions). Connect the device controlled by the programmable output between terminal 8 (+) and terminal 14 (-). A programming option "Aux. Output Chirp on Key-fob Arming" is available. If selected, an external siren driver can be connected to these terminals.

WIRING CONNECTIONS

REMOTE BUS

NOTE: Refer to the EZM Installation Instructions for specific wiring information.

- AVAILABLE DEVICES**
1. **KEYPADS:** GEM-RP1CAe2, GEM-RP2ASe2 & GEM-RP3DGTL
 2. **X-10 INTERFACE:** GEM-X10
 3. **WIRED ZONE EXPANDER:** GEM-EZM4 & GEM-EZM8
 4. **WIRELESS RECEIVERS:** GEM-RECV8, GEM-RECV16 & GEM-RECV96
 5. **RELAY MODULE:** RM3008
 6. **VOICE INTERFACE:** GEM-EVA 1
 7. **TELEPHONE INTERFACE:** WIZARD IIe

WIRING CONNECTIONS

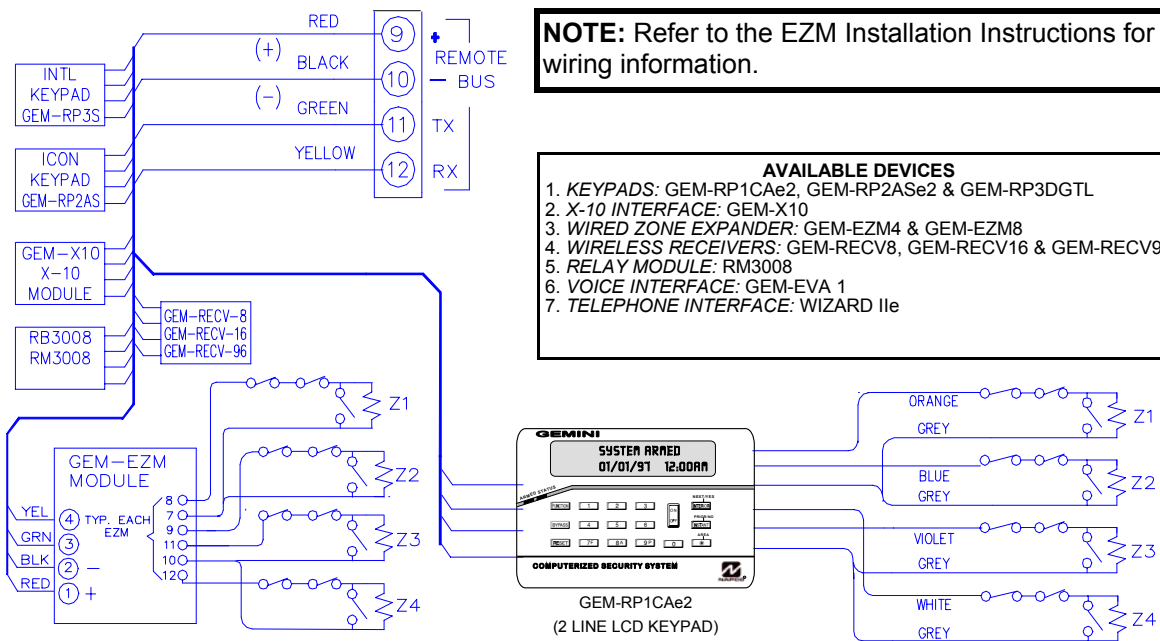

Connect the available devices as shown above to the remote bus terminals (9, 10, 11 & 12). Observe the correct color wire connections. When connecting a keypad, first configure them accordingly (refer to the Keypad Configuration Mode at the back of this manual). Keypads should be located near every exit/entry door. Up to seven keypads may be connected if the longest cable run from the panel, to the farthest keypad (daisy chained or home-run) is less than 1000 feet. The maximum distance for seven keypads is 300 feet using 22 AWG. wire. **NOTE:** When running keypad wire, avoid wiring parallel to other types of wiring that can cause electrical interference.

EARTH GROUND

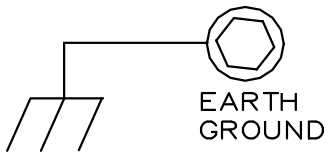

NOTE: Do not use a gas pipe, plastic pipe or AC ground connections.

Connect the control panel EARTH GROUND screw through a No. 16 AWG. or larger wire to a metal cold-water pipe. Do not use a gas pipe, plastic pipe or AC ground connections. Also, connect the circuit board to the metal enclosure. Connect a wire with a ground lug crimped or soldered onto one end of the EARTH GROUND screw to the cabinet. **NOTE:** Grounding connections should avoid bends in the grounding wire whenever possible.

AUXILIARY POWER

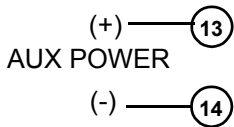

Connect the auxiliary devices (motion detectors, glass breaks, etc.) to Terminals 13 and 14. Auxiliary Power provides a filtered 12 VDC nominal output which is used for powering auxiliary devices. **NOTE:** To calculate the available standby time refer to the Standby-Battery Calculation Worksheet at the back of this manual.

RESET OUTPUT

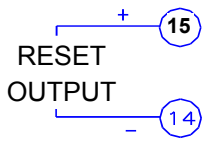

Reset Output can be activated depending on the programming options selected (see GEM-P9600 Programming Instructions). Connect the device controlled by the programmable output between terminal 15 (+) and terminal 14 (-).

BASIC ZONE CONFIGURATION

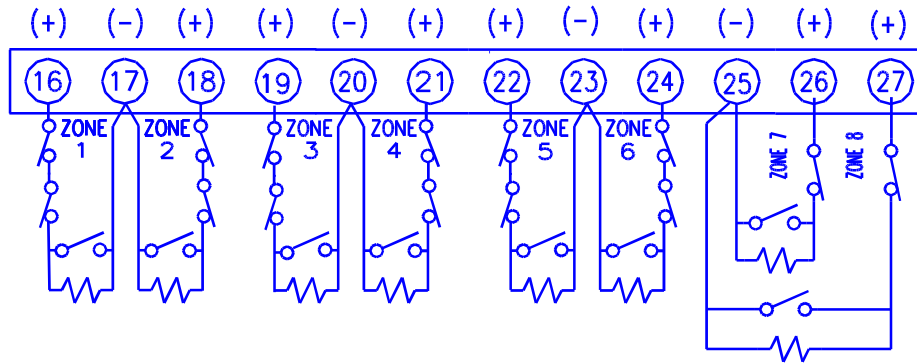

The basic zone configuration for the GEM-P9600 is 8 zones. Connect as shown above to terminals 16-27. Normally Closed (N.C.) devices may be wired in series or Normally Open (N.O.) devices may be wired in parallel. Use the 2.2K Ohm end-of-line (E.O.L.) resistor in each zone, if selected in programming (refer to the GEM-P9600 Programming Instructions). Zones 1-8 can be selected for a "Fast Loop Response (10ms or 50 ms)" or a "Normal Loop Response (750 ms)". Other zone options include Zone Type (Entry/Exit, Interior, 24 Hour Protection, Trouble and Fire), Instant, Chime, Area Selection and Relay Output selection.

WIRING CONNECTIONS

EXPANDED ZONE CONFIGURATION

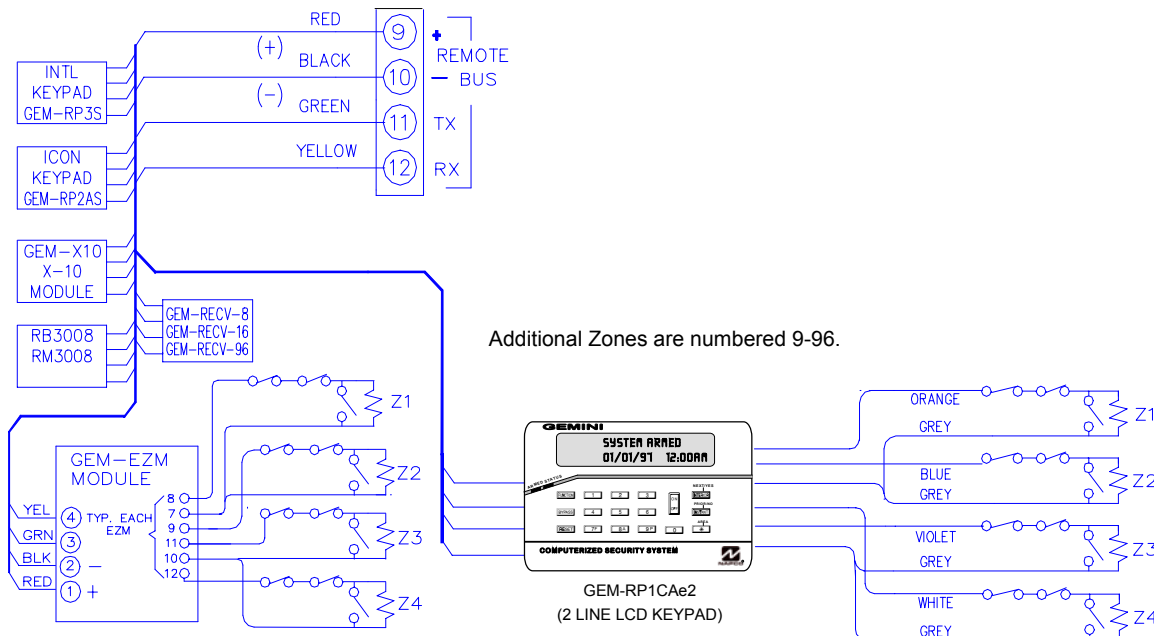

The GEM-P9600 Control Panel may be expanded up to 96 zones. This may be accomplished by adding 88 zones to the basic 8 zone configuration. Hardwired zone expanders include: GEM-EZM4 (4 additional zones per module), GEM-EZM8 (8 additional zones per module) and GEM-RP1CAe2 Keypad (4 additional zones per keypad). Wireless zone expanders include: GEM-RECVR8 (8 additional zones per receiver), GEM-RECVR16 (16 additional zones per receiver) and GEM-RECVR96 (88 additional zones per receiver). Wireless transmitters include: GEM-TRANS2, GEM-KEYF, GEM-SMK, GEM-PIR, GEM-DT and GEM-GB.

4-WIRE SMOKE DETECTORS

4-WIRE SMOKE DETECTOR WIRING

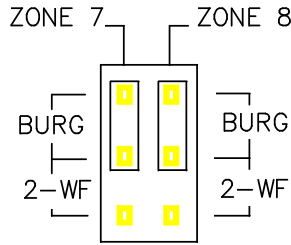
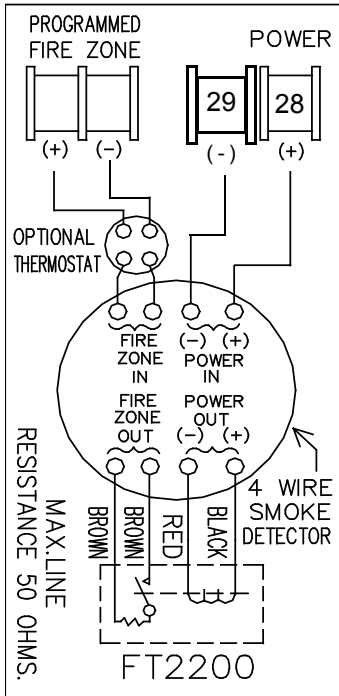

The GEM-P9600 can use conventional 12 VDC 4-wire smoke detectors. To use them, the select fire zone programming option and do not select 2-wire smoke detector programming option for the desired fire zone (refer to the GEM-P9600 Programming Instructions). Set JP7 to the BURG position as shown, if zones 7 or 8 are to be used.

Four wire smoke detectors may be connected to any programmed fire zone (1-8) as shown, within the panel. If external EZMs are used for zones 9-96, then 4-wire smoke detectors may be connected to any programmed fire zones (9-96).

Power must be obtained from terminal 28 (+) and 29 (-). If Fire Alarm Verification is desired to reset the smoke detectors, select this option for the desired fire zone.

NOTE: Do not program Fire Alarm Verification in California

WIRING CONNECTIONS

2-WIRE SMOKE DETECTORS

2-WIRE SMOKE DETECTOR WIRING

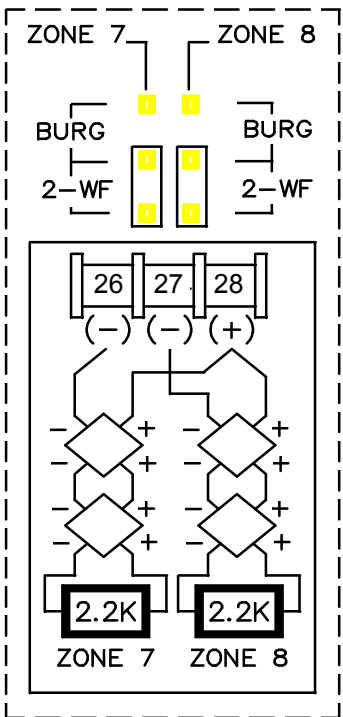

Two-wire smoke detectors may be connected to control panel zones 1-8. Zones 7 and 8 may be configured for 2 wire fire through the JP7 jumper settings, while zones 1-6 may be configured for 2 wire fire with the use of an EOL130 resistor and the cut of a control panel resistor. To enable, program the zone(s) as Fire Zones, enable 2-Wire Fire (refer to the GEM-P9600 Programming Instructions) and set JP7 to the position as shown. Connect the 2-wire smoke detectors as shown.

If Fire Alarm Verification is desired to reset the smoke detectors, select this option for the desired fire zone (zone 7 or 8).

NOTE: Do not program Fire Alarm Verification in California

2-WIRE SMOKE DETECTORS

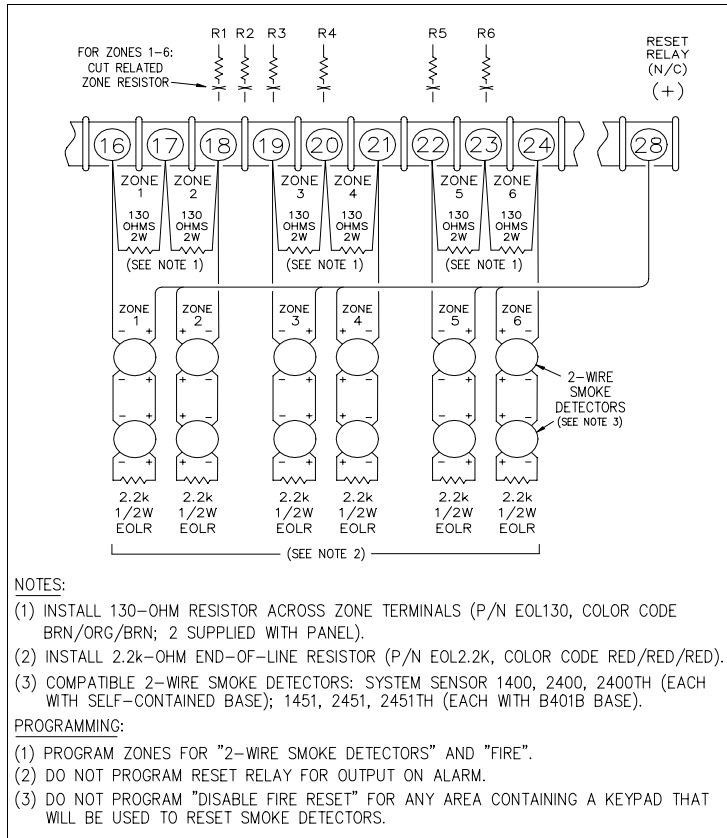

Connecting 2-wire smoke detectors to zones 1-6

Where more than two 2-wire smoke detector zones are required, select any of Zones 1-6 for 2-wire fire as follows:

1. Program the selected zone(s) (1-6) for 2-Wire Smoke Detectors and Fire.
2. Cut the lead of the 2700W resistor (color code: red/violet/red) associated with the selected zone(s). See following table.

ZONE	RESISTOR	LOCATION ON BOARD
1	R1	ABOVE TERMINAL 18
2	R2	ABOVE TERMINAL 18/19
3	R3	ABOVE TERMINAL 19
4	R4	ABOVE TERMINAL 20
5	R5	ABOVE TERMINAL 22
6	R6	ABOVE TERMINAL 23

3. Install a 130W resistor (Napco Part No. EOL130; color code: brown/orange/ brown), 3 watts, across the two terminals of each selected zone.
4. Wire the positive (+) terminal of the smoke detector to Terminal 28. Wire the negative (-) terminal of the smoke detector to the positive terminal (+) of the zone.

WIRING CONNECTIONS

TELEPHONE LINES

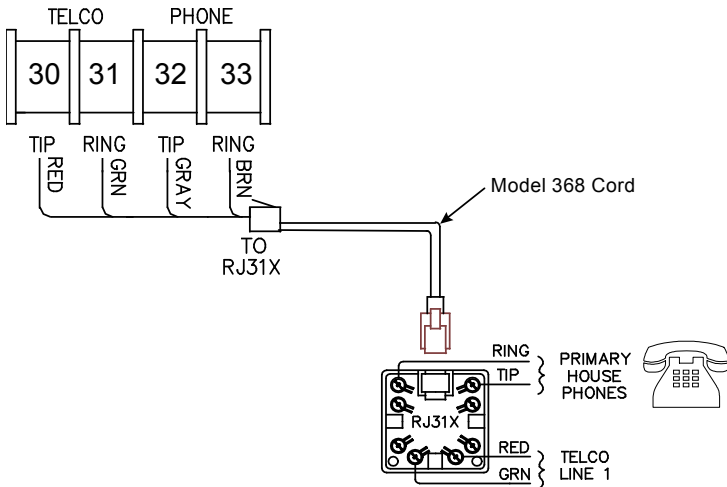

Connect the Model 368 Cord as follows: 30 (RED = Telco Tip), 31 (GREEN = Telco Ring), 32 (GRAY = Home Tip) and 33 (BROWN = Home Ring). Insert the modular plug into an approved USOCRJ31X jack (or a CA31A jack for Canadian installations). The Telco Line is used by the control panel to dial the central station and for downloading. This line should not be connected to party lines or coin operated telephones. If connected to a line with call waiting, then call waiting interrupt numbers must be programmed into the CS Telephone Numbers (refer to the GEM-P9600 Programming Instructions).

KEYPAD CONFIGURATION MODE

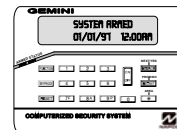

This section will focus on configuring the GEM-RP1CAe2, GEM-RP2ASe2 and GEM-RP3DGTL Keypads. If there is more than one keypad in the system, *only Keypad No. 1 may be used for programming.*

KEYPAD INSTALLATION

Three types of keypads may be used with the GEM-P9600: the GEM-RP1CAe2, the GEM-RP2ASe2 and the GEM-RP3DGTL. Each must be assigned an address number (1–7) and each requires its own configuration procedure (see CONFIGURING THE KEYPADS, which follows, and DIRECT ADDRESS KEYPAD AREA OPTIONS). At least 1 keypad must be used; only 1 is required for a single-area Commercial Burglary installation.

GEM-RP1CAe2 - is a 2-line combination fire/burglary/access keypad capable of supporting 4 EZM zones and a PGM output. A GEM-RP1CAe2 is recommended for use as Keypad #1.

GEM-RP2ASe2 - is a fixed English Alpha Symbol LCD keypad combining several preset LCD words with a limited message line.

NOTE: Due to space constraints, available messages are abbreviated and will scroll automatically.

GEM-RP3DGTL - is a Digital Display numeric keypad combining a dual seven segment display with LED indicators to convey system status.

CONFIGURING THE KEYPADS

A total of up to 15 keypads may be connected to the panel. GEM-RP1CAe2, GEM-RP2ASe2 and GEM-RP3DGTL keypads may be intermixed but require different configuration procedures, as described in the following paragraphs. However, Keypads 8 - 15 may only be GEM-RP1CAe2 model.

Configuring the GEM-RP1CAe2 Keypad

Each GEM-RP1CAe2 keypad must be configured for (a) keypad tactile beep; (b) entry sounder; (c) keypad address; (d) compatibility number; (e) EZM address; and (f) zone response.

To enter the GEM-RP1CAe2 Configuration Mode:

1. Move jumper JP5 (located at the upper-right corner of the control panel board) from Pins 1-2 (top two) to Pins 2-3 (bottom two). **NOTE:** See Wiring Diagram.
2. After about 15 seconds, the display will read "XX OUT OF SYSTEM", where XX indicates the keypad address.
3. Press and proceed as follows. (Repeat the following procedure for all keypads.)

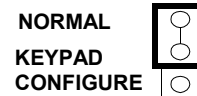

KEYPAD CONFIGURATION

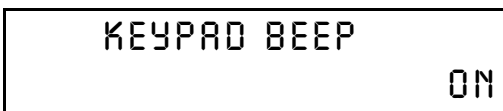

Keypad Tactile Beep

Upon entering the Keypad Configuration Mode, "KEYPAD BEEP ON" will be displayed, indicating that the tactile beep, which sounds when any button is pressed, is on. To turn off the tactile beep, press the button (the button will toggle the tactile beep on and off).

Press the button to continue or press the button to exit.

Entry Sounder

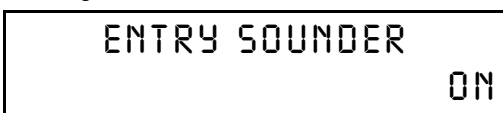

To turn off the keypad sounder during entry time, press the button (the button will toggle the tactile beep on and off). Press the button to continue or press the button to exit.



Keypad Address

If more than one keypad is installed, each must be assigned a unique keypad address (that is, no two keypads may be numbered alike):

- ☞ keypads must be numbered consecutively (missing numbers are not permitted)
- ☞ only Keypad No. 1 may be used for programming.

To assign the keypad number, proceed as follows:

1. Enter the assigned keypad number 01–15, then press the button to save. A valid number will be acknowledged by a short beep; an invalid number will be rejected by a long beep.
2. Press the button to continue or press the button to exit.





Compatibility Number

The compatibility number is a 4-digit security code that, if programmed into both the control panel and each GEM-RP1CAe2 keypad, dedicates the keypad to only that panel. That is, (a) similar keypads not having the correct compatibility number will not operate in the system and (b) a keypad may

not be removed for use on a system with a different compatibility number. **Note:** (1) If assigning compatibility numbers, record and store them in a safe place. (2) The GEM-RP2ASe2 and GEM-RP3DGTL Keypads will function with or without a Compatibility Number.

While the compatibility number may be changed, the old number must be known in order to program the new number.



Note: If neither the control panel nor the keypad is given a compatibility number, both default to "0000" (thereby maintaining compatibility).

To program the compatibility number, press the  button until "NEW COMPAT# 0000" is displayed. Enter the 4-digit compatibility number that is programmed into the panel. **Note:** If the keypad had been previously programmed for a compatibility number other than "0000", the display would read "OLD COMPAT# XXXX". Enter the existing number before attempting to change it. Press the  button to continue or press the  button to exit.



EZM Address

The keypad's internal EZM (Expansion Zone Module) may be utilized to provide four additional wired zones. Whether used alone or in conjunction with optional GEM-EZM series modules or other keypad EZMs, it must be assigned a unique address (or Group number, see Keypad Programming Workbook) similar to its keypad address. If no other EZMs are to be used,

designate the keypad as Group "01" at the "EZM ADDRESS 00" display. In multiple-EZM systems, enter an assigned group number "01" through "06". (Each EZM must have a unique assigned group number, starting with "01" and proceeding consecutively.) Press the  button to continue or press the  button to exit.



Zone Response



The normal loop response of each keypad expansion zone is 750mS, however the response time of any zone can be reduced to 50mS as follows.

1. Of the following, circle the number(s) in parentheses associated with the zone(s) to be changed: Zone 1=(1); Zone 2=(2); Zone 3=(4); Zone 4=(8)
2. Add up the circled numbers.

3. At the keypad, enter the sum as a two-digit number "01" through "15" on the display, then press the  button.

Example. Change Zones 2, 3 and 4 to 50mS response.

1. Circle numbers for Zones 2, 3 and 4: (2), (4) and (8).
2. Add up the circled numbers: 2 + 4 + 8 = 14.
3. Enter "14" at the keypad, then press the .



Press the  button to continue or press the  button to exit.

Program Control Message



The Access-Control message normally displays "***ENTER NOW**" however this display may be changed to any of the following messages:

ENTRY	MESSAGE
0	"***ENTER NOW**" (Default)
1	"DOOR CONTROL"
2	"GATE CONTROL"
3	"LIGHT CONTROL"
4	"CONTROL #1"
5	"CONTROL #2"
6	"CONTROL #3"

Press the  button to continue (the display will loop back through selections, for changes) or press the  button to exit the Keypad Configuration Mode (display will read "01 OUT OF SYSTEM"). Then replace Jumper JP5 across Pins 1–2 (top two).

KEYPAD CONFIGURATION

Configuring the GEM-RP2ASe2 and GEM-RP3DGTL Keypad

Up to 7 GEM-RP2ASe2 and/or GEM-RP3DGTL keypads may be connected to the panel (Keypads 1–7). Each must be configured for a keypad address. In addition, the keypad may be configured to disable (a) touchpad backlight; (b) LCD backlight; and (c) entry sounder. Keypads are configured by the proper selection of jumpers. Refer to the label on the circuit board insulation paper for jumper locations and a summary of settings.

KEYPAD NUMBER	KEYPAD NUMBER			PARK
	1	2	3	
1	OFF or ON*	OFF	OFF	STORE SPARE JUMPER AT THIS POSITION
2	OFF	ON	OFF	
3	ON	ON	OFF	
4	OFF	OFF	OFF	
5	ON	OFF	ON	
6	OFF	ON	ON	
7	ON	ON	ON	

KEYPAD ADDRESS

If more than one keypad is installed:

☞ Each must be assigned a unique address (that is, no two keypads may be numbered alike).

☞ Keypads must be addressed consecutively (that is, missing numbers are not permitted).

☞ Only Keypad No. 1 may be used for programming. (However, for ease of programming, it is recommended that a GEM-RP1CAe2 be selected as Keypad #1.)

Assign the keypad address number by selecting Jumpers J1–3 in accordance with the table at left.

***Note:** (1) Keypads are factory supplied with no jumpers installed and as such are automatically configured as Keypad No. 1. (2) Only one keypad in the system may be configured as Keypad No. 1, otherwise none will function.

TOUCHPAD BACK LIGHT

Cut Jumper A to disable touch pad backlighting to conserve 11mA standby current.

LCD BACKLIGHT

Cut Jumper B to disable LCD backlighting.

DISABLE SOUNDER

Cut Jumper C to disable the sounder. (Do not disable in UL applications.)

KEYPAD CONFIGURATION



NAPCO Security Systems, Inc.
 333 Bayview Avenue, Amityville, New York 11701
 For Sales and Repairs, call toll free: (800) 645-9445
 For direct line to Technical Service, call toll free: (800) 645-9440
 Internet: <http://www.napcosecurity.com>

BASIC OPERATION

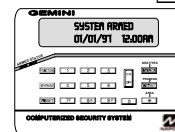

This section provides a brief overview of system operation. For detailed operation, refer to the User's Guide furnished with the keypad (OI193 for the GEM-RP1CAe2; OI192 for the GEM-RP2ASe2 and OI249 for the GEM-RP3DGTL) and to the Keypad Programming Modes at the end of this manual. **NOTE:** MOST Keypad displays shown in this text are for the GEM-RP1CAe2 keypad. GEM-RP2ASe2 displays will be similar, although abbreviated, and GEM-RP3DGTL displays will be in a digital format.

USER CODES & ZONE DESCRIPTIONS

(Refer to the GEM-P9600 Programming Instructions (W777) for a detailed explanation of programming.) Up to 96 personal user codes may be programmed at the keypad. **NOTE:** The Authority Level and Access Byte associated with each User Code may only be programmed in the Dealer Program Mode.

Default User Code

The first code programmed should replace the default (Level-3) code, "U01 123 ••• - ••• - ••", (1,2,3), which should not be selected as a user code. Enter up to six digits (a minimum of four digits is recommended). The related Option Code and Authority Level are programmable in the Dealer Program Mode only.

Each user should be assigned his own dissimilar code and should be cautioned against divulging his code to anyone else. Thus should it become necessary to remove a user from the system, that one code may be canceled without affecting other codes, and that user would then be prevented from entry. **NOTE:** NAPCO's PCD3000 Quickloader Software provides enabling and disabling User Codes at programmed times using the scheduling menus.

Changing or Canceling a Code

To change any code, merely program over the existing code as described in the Programming Instructions. Similarly, to cancel a code, blank out each number of the code.

Arm/Disarm Code (Programmable in Dealer Program Mode only)

An Arm/Disarm Code may be used to arm/disarm the area in which it is programmed. Up to 6 digits may be programmed or it may be programmed as a two-digit code for the purposes of quick arming.

Arm-Only Code (Programmable in Dealer Program Mode only)

An Arm-Only Code may only be used to arm the area in which it is programmed; it never has any disarm capability. Up to 6 digits may be programmed or it may be programmed as a two-digit code for the purposes of quick arming.

Service Code (Programmable in Dealer Program Mode only)

A Service Code is an Arm/Disarm Code that is easily activated when needed, and dormant at other times. Intended for the occasional or temporary user (maid, repairman, etc.) who would otherwise be denied access to the premises, it is programmed in conjunction with the Authority Level when programming User Codes. Refer to Programming Instructions.

It is activated by arming with it; an "S" will appear in the display (GEM-RP1CAe2 only) after the exit-delay countdown, indicating that a Service Code has been activated. It may then be used to arm and disarm just as any other User Code. Service code can be armed/disarmed from a disarmed state, but it cannot be armed/disarmed from an armed state, after another user code has been entered.

Panel Access Code

The Panel Access Code will trip the panel's Auxiliary Relay while disarmed if Access Control on Auxiliary Relay is programmed. The Panel Access Code is programmed as any other User Code but without an accompanying Priority Level. *Caution:* Do not use the same code as any Arm/Disarm Code. **Note:** These systems have not been investigated by UL for compliance with UL294 (Access Control Systems).

Program Keypad Time and Date in User Program Mode (GEM-RP1CAe2 firmware version 6 or greater required)

When using an GEM-RP1CAe2, the Time and Date may be set in the User Program Mode.

Keypad Access Code (Programmable in Dealer Program Mode only)

Any User Code may have Keypad Access through a door with a striker by programming the keypad's Access Byte. Program the Keypad Access Lug for the applicable keypads 1 through 8. If the Access Byte is programmed, that User Code will function only an Access Code and not as an Arm/Disarm Code. Entering the code will cause a 5-second active-low output on the PGM line with a pulsing sounder at the keypad and "***ENTER NOW**" (or other customized









message) displayed. **Note:** (1) Keypads may be programmed for access only, eliminating their arm/disarm function (keypad will then normally display “**ENTER CODE**”). (2) Keypad access may be logged into the event log by keypad.





Ambush Code

The Ambush Code is a two-digit code entered by the user just prior to disarming, typically to cause a silent report to be sent to the central station. Thus, should the user be forced to disarm by an assailant, he can silently signal an emergency while appearing to be merely disarming the panel. (Check the glossary for programming required to enable this feature.) Ambush Code should not contain digits used as the first two digits of any user code.

Zone Descriptions (GEM-RP1CAe2 only.)

Zone descriptions follow the Program Code in the normal programming sequence (“01-” will appear in the display). Program the description, up to two lines, letter by letter. Buttons  and  control the position of the cursor.

Buttons   will clear the entry at the cursor. When programming zone descriptions, buttons  and  will scroll not only through numbers 0-9, but through the alphabet and a series of punctuation marks and symbols as well. (Roughly note the order in which the letters, numbers and symbols are displayed so that you will be able to determine the proper direction to scroll, up or down, for fastest access. As familiarity improves, so will programming speed.) When the description has been entered and is satisfactory as displayed (e.g. “GARAGE”), press the  button to save it in memory.

To advance to the next zone (or to any other zone, for that matter), position the cursor over the displayed Zone Number, i.e., “01” using buttons  and . Change the Zone Number using buttons  and . Repeat the zone-description programming procedure for the new zone. Advance to the next zone and repeat until all zones (up to 96) have been programmed.

ARMING AND DISARMING THE SYSTEM





In the normal disarmed state, only the green STATUS LED will be on and the display will read “SYSTEM READY”. To silence an alarm, enter any User Code, then press the  button. Any valid User Code may be used to arm or disarm; an Arm-Only Code may only be used to arm.

Arming

 To arm, enter a valid User Code, then press the  button.

(If a wrong code is entered, the keypad will display “INVALID ENTRY / TRY AGAIN”.) The green STATUS LED will go off, the red ARMED LED will go on, and the display will read “EXIT TIME XXX” (“XXX” representing the programmed exit-delay time, in seconds). The exit delay will immediately start counting down toward “000”, in 10-second decrements, indicating the available time remaining to exit through an exit/entry door.

Note:

-  1. If Exit Delay Restart is enabled, after the panel is armed and the exit door is opened and then closed, exit delay will restart at 60 seconds. If re-entry occurs within this 60-second interval, the alarm device will sound a 2-second warning “chirp”, if programmed, as an entry reminder to the user to return to the keypad and disarm.
-  2. (GEM-RP1CAe2 only.) An “S” in the display (e.g. “EXIT TIME XXX S”) will appear as a reminder that the system is being armed with the Service Code active. (To turn off the Service Code, disarm, then rearm using a regular Arm/Disarm Code.)
-  3. If the System Trouble is displayed, there should be an attempt to correct the system trouble (for example by calling an alarm maintenance or an alarm repairman). If this cannot be done, then press the  button to allow 5 minutes to access the keypad without the system trouble displayed. Immediate attention should be provided, when system troubles are encountered.
-  4. In commercial applications, if Start Exit Delay After Ringback is programmed, exit delay will not start until the central station acknowledges receipt by a ringback tone at the keypad. The display will read “PLEASE WAIT” while the control panel communicates to the central station. If the ringback tone does not sound within about 30 seconds, the START EXIT TIME function may be used to manually start exit delay.



Disarming

When the exit time has elapsed, the display will read "SYSTEM ARMED". This indicates that upon entering the premises through an exit/entry door, there will be an entry delay to allow time to disarm the panel. The GEM-RP1CAe2 display will read "ENTRY TIME XXX" ("XXX" representing the programmed entry-delay time, in seconds). The sounder will come on and the entry delay will immediately start counting down toward "000" in intervals of 10 seconds, indicating the available time remaining to disarm the panel. The sounder will pulse during the final 10 seconds.

 To disarm the panel, **enter a valid User Code, then press the  button.**

Arming with No Delay

 Press the  button prior to or after arming.

This feature allows normal exit delay, but cancels the next entry delay through an entry/exit zone. The display red LED will flicker. This feature may be used to provide instant protection while you or someone else is still on the premises. It will be canceled automatically upon disarming.

Priority Arming

A 2-second tone and "ZONE NOT NORMAL/CAN'T ARM" displayed when attempting to arm indicates a priority condition; that is, a problem exists on at least one zone that has been designated a Priority Zone, or a system trouble exists. The trouble(s) must be corrected before the panel can be armed. The display will read "ZONE FAULTS", then automatically scroll through all unsecured zones. If a system trouble is indicated, display the system trouble.

Area Arming/Overview Mode

In a partitioned system, either or both secured areas may be armed (or disarmed) simultaneously from either the Overview Mode or the Manager's Mode (if enabled). To arm or disarm the alternate area, see Keypad Area Change, which follows.

Overview Mode



To enable or disable Overview, see ACTIVATE OVERVIEW function later in this section. The Overview Mode is a high security mode of operation requiring a Level-3 User Code with Overview Option, wherein the status of both areas is displayed at the keypad. When arming, the "home" area remains disarmed. To arm the alternate area, see Keypad Area Change, which follows.

In the Overview Mode, "0V[-]" will be displayed, where each dash ("-") represents an area. In programmed areas, the dash will be replaced by one of the following:

- "A" = Area Armed
- "B" = Burglary Zone in Alarm
- "C" = Check Trouble; Area in Function-Display Mode
- "F" = Fire Zone in Alarm
- "R" = Area Ready (no faulted zones)
- "T" = Fire Trouble
- "Z" = Zone Fault

 In the Overview Mode, **the alternate ready area may be armed by pressing the   buttons.**



Note: The User Code must be valid in that area.

 Similarly, **the alternate armed area ("A") may be disarmed by pressing the   buttons.**

If any zone is not secured, the system will not arm and the keypad will display "CAN'T ARM SYSTEM / AREA # IN TROUBLE", where "#" represents the area number.

Manager's Mode

The Manager's Mode, in contrast to the Overview Mode, is a low-security mode of operation.

 Unlike the Overview Mode, **when arming both areas press   and enter a valid user code, the "home" area will also arm.**





As in Overview, if any zone is not secured, the area will not arm and the keypad will display "CAN'T ARM SYSTEM / AREA # IN TROUBLE", where "#" represents the area number.

 To disarm both areas, **press   and enter a valid user code.**

 To arm the alternate area, see Keypad Area Change.

Keypad Area Change

To arm or disarm the alternate area:



1. Press the number button (1-8) representing the alternate area.
2. Press the  button, then the  button. The keypad will display "SYSTEM READY X", where "X" denotes the area selected. In effect, you will now be in that area.
3. Arm or disarm the area using your code (the code must be valid in that area).
4. To return the keypad to its "home" area, press the  button, then the  button.

Note: If the "home" keypad has been changed to the alternate area and unused for more than 5 minutes, it will revert to the home area.

BYPASSING ZONES

Security Bypass



Zones programmed for Selective Bypass may be removed from the system prior to arming as follows:



1. Enter a code valid for bypass (Authority Level 1 or higher and Bypass option enabled), then press the  button; "BYPASS ENABLED" will display.
2. Press the  button, then the zone number (or vice versa) to deactivate that zone.

Note: When the panel is subsequently disarmed, all bypassed zones revert to unbypassed zones (unless Disable Auto-Unbypass on Disarming is programmed or Interior Zones are programmed normally bypassed).



Easy Bypass (Do not enable in UL applications.)

Enable this feature by programming Disable Code Required for Easy Bypass. Then, zones programmed for Selective Bypass may be bypassed quickly and easily as follows. **Note:** This is not a high-security feature.

1. At the "SYSTEM READY" or "ZONE FAULT" display, enter the zone number as a two-digit number (ex., "01", "15", etc.). Zones cannot be bypassed while the panel is armed.
2. Press the  button. To unbypass the zone, press the  button again. **Note:** Steps 1 and 2 may be reversed and this feature will still function.)

Note: If Bypass Faulted Zones is programmed, pressing the  and the  buttons simultaneously will bypass all zones in trouble (except Fire and PIR Zones) that are also programmed for Selective Bypass.

Bypassing Interior Zones





Interior zones allow perimeter zones to be armed while part or all of the active interior remains disarmed. When the  button is pressed, the "BYPASSED" reminder will come on. Pressing the  button within 10 seconds will bypass the selected interior group without arming, otherwise Interior Bypass will time out and the system will revert to the regular disarmed state. All zones designated for the selected interior group(s) will be bypassed simultaneously when the system is armed. The alarm conditions will then be stored in the Alarm History Log and the Total Event Log (see HISTORY LOG).

ALARM INDICATION

- To silence an alarm, enter a valid User Code, then press the  button.



Should a burglary alarm occur, the red ARMED LED will flash, and the display will alternately read "ALARM", then the zones violated. Disarm the panel; the display will read "ALARM" and will continue to indicate the violated zones until the  button is pressed or the panel is armed once again.

FUNCTION MODE/DEALER PROGRAM MODE



The keypad can provide a wide assortment of utility functions as summarized in the Keypad Programming Modes. The functions are displayed in a prompting “YES/NO” format. To skip a function, answer NO (press the  button); to select and execute a function, answer YES (press the  button or the  button). The complete function list is provided here in its normal displayed sequence. However, since not all functions are designed for all systems (or intended for all users), only functions that are applicable and active are displayed. (For example, if no zones are bypassed, “DISPLAY ZN BYPASSED” will not appear.) Furthermore, functions that are intended for use by the installer or servicer will not be displayed. **Note:** Functions may be manually scrolled forward or backward using the  and the  buttons, respectively.

To return to normal keypad operation, press the  button. (The keypad will automatically return to its normal operating mode if no activity is detected for longer than one minute.)



Note: (1) In all UL-listed applications and in high-security installations, only those users having valid codes can access the Function Mode. (2) Due to space constraints, GEM-RP2ASe2 message displays are abbreviated.

Remember: (1) Functions that are not active, not programmed and/or not applicable to the user's authority level will be suppressed and will not display. (2) Press NO ( button) to skip a function; press YES ( button) to execute it. (3) The GEM-RP2ASe2 displays abbreviated messages that auto scroll.



DISPLAY ZN FAULTS

Press YES ( button) to identify all unsecured zones (within the keypad's area) while disarmed. Press NEXT ( button) to scroll through the zones. (Zones may be bypassed in this mode by pressing the  button). Manually bypassed zones will be indicated when displaying status.

DISPLAY ZN BYPASSED

Press YES ( button) to display zones that have been deactivated. Press NEXT ( button) to scroll through the zones.



DISPLAY ZN DIRECTORY

Press YES ( button) to display a list of all programmed zone descriptions in the keypad area. Press NEXT ( button) to scroll through the zones. To return to the system, press the  button at any time.



ACTIVATE BELL TEST

Press YES ( button) to activate the burg relay output (while disarmed) for about 2 seconds. If the device does not sound, it may be defective.



DISPLAY PHONE #'S

The panel can function as an auto dialer to any of four programmed telephone numbers. (Telephone numbers must be programmed through Napco PCD3000 Quickloader software.) Select Telephone #1-4 using NEXT () and PRIOR () buttons, then press the  button. Pick up the phone to initiate dialing of the displayed number. (The phone will appear to be disconnected while dialing but will return to normal after a few seconds.)

DISPLAY SYS TRBL



Press YES ( button) to check trouble (LOW BATTERY, AC POWER LOSS, etc.). Wait for the display to scroll through multiple system troubles, or use the NEXT () and PRIOR () buttons to manually scroll.

DISPLAY FIRE ALARM

To display Fire Zone(s) in alarm, access DISPLAY FIRE ALARM and scroll through the zones using the NEXT ( button). Correct the problem, then press the  button to restore the “SYSTEM READY” condition.







DISPLAY FIRE TRBL

To display Fire Zone(s) in trouble, access DISPLAY FIRE TRBL and scroll through the zones using the  button. Correct the problem, then press the  button to restore the "SYSTEM READY" condition.

DISPLAY OP/CL

NAPCO's PCD3000 Quickloader software offers a comprehensive array of programmable opening and closing suppression windows, by area, for all days of the week, for both normal and holiday schedules. A two-line display of the programmed schedule may be read at the keypad. The first line indicates:

- ✓ the day of the week
- ✓ opening or closing suppression window
- ✓ "AUTO", if autoarming
- ✓ normal (or delayed) schedule (see below)



To scroll through the days of the week, use the  and  buttons. The closing of any suppression window may be delayed up to four hours at the keypad, or the window may be totally disabled, up to one week in advance. Select the DAY/OP/CL schedule using the  and  buttons. Select the delay (1-4 hours) or disable using the  button.

Note: If the schedule includes autoarming, arming will be delayed accordingly. Also see Autoarm Function. (Autoarming can be disabled or delayed by area using PCD3000 software.)

ACTIVATE OVERVIEW

This mode provides a system status display of both partitioned areas at a glance. **Note:** The keypad selected for the Overview Mode will remain in that mode. To convert the keypad back to its original use as an area keypad, enter the Function Mode and access DEACTIVATE OVERVIEW. The display will revert to "SYSTEM READY". Also see Overview Mode.



ACTIVATE CHIME *

Press YES () to sound a tone at the keypad when a Chime Zone is violated. The duration of the tone is programmable. To turn off the Chime Mode, press YES () at the DEACTIVATE CHIME function.

ACTIVATE WATCH*

This option, if programmed, permits all zones designated as Day Zones to be turned on. When selected, a "W" will appear in the display (GEM-RP1CAe2 only) as long as the Watch Mode is active. To deactivate the Watch Mode, arm, then disarm.

RESET SYSTEM TRBL

System troubles normally latch and display and sound at the keypad. Pressing the  button will silence the sounder; "SYSTEM READY" will be displayed. Correcting the trouble will clear most system trouble indications, however the following system troubles require a Level-2 or -3 code for manual reset (enter code; access RESET SYS TRBL then press the  button.)

- ✓ EZM Tamper
- ✓ Keypad Tamper
- ✓ Sensor Watch
- ✓ Service Reminder

Note: (1) If a system trouble is not corrected, it will redisplay after 5 minutes. (2) If one or more of the foregoing system troubles appear during the first 5 minutes after power-up, they will be cleared automatically.

RESET SENSOR MSG

Press YES () to reset a PIR Supervision system trouble.

START EXIT TIME

If the central station ringback signal has not been received within about 30 seconds, a communication problem may exist. Press YES () to start exit delay manually.

FAULT FIND

This troubleshooting aid will help the installer locate swingers. When accessed, two things occur:



- ✓ The loop response of each zone is set for the fastest response time.
- ✓ Causing or repairing a fault activates the sounder for about 7 seconds.

Tapping and poking at suspect points, the installer can easily locate swingers by listening for the beep. This eliminates the need of returning to the keypad to visually check after each attempt. Pressing the  button to restore normal operation. Arming the system automatically cancels the Fault find Mode. **Note:** When testing wireless systems, the keypad will not beep if the signal strength is less than 3, but the strength will still be displayed.

ACTIVATE LOCATE

This feature will help the user find zone troubles and indicate when they are repaired. When accessed, the sounder will come on and the display will read "LOCATE", then scroll through the zones in trouble. As each zone is corrected, the sounder will stop momentarily, signaling its repair, and the display will indicate the remaining zones in trouble. The sounder and display will continue in this manner until all zones are repaired, or until the  button is pressed.

EZM ZONE FIND

To find the physical location of an EZM, enter the number of any zone on that EZM, then press the  button. This will cause the EZM sounder to pulse continuously until silenced. To silence the sounder, press the  button on any keypad.

ACTIVATE DIALER TEST

Press YES to send a digital dialer test code to the central station using the system account number. (Be sure to notify the central station of the impending test.) A successful test will clear a Failure to Communicate system trouble. The History Log documents the 800 most recent events.

DISPLAY ALARM LOG (Not available with GEM-RP2ASe2 or GEM-RP3DGTL Keypads)

Displays most recent alarm events. Line 1 displays event and date. Line 2 displays time, area and zone. To check previous alarm events, scroll back using the PRIOR () button.

DISPLAY TOTAL LOG (Not available with GEM-RP2ASe2 or GEM-RP3DGTL Keypads)

Displays most recent events of all types. Line 1 displays event and date. Line 2 displays time and, if applicable, area and zone or user. To check previous events, scroll back using the PRIOR () button.

DISPLAY FIRE LOG (Not available with GEM-RP2ASe2 or GEM-RP3DGTL Keypads)

Displays most recent fire events. Line 1 displays event and date. Line 2 displays time, area and zone. To check previous fire events, scroll back using the PRIOR () button.

DISPLAY OP/CL LOG (Not available with GEM-RP2ASe2 or GEM-RP3DGTL Keypads)

Displays most recent openings and closings. Line 1 displays event and date. Line 2 displays time, area and user. To check previous events, scroll back using the PRIOR () button.

DISPLAY SYSTEM LOG (Not available with GEM-RP2ASe2 or GEM-RP3DGTL Keypads)

Displays most recent system events. Line 1 displays event and date. Line 2 displays time and other pertinent information, where necessary, depending upon event. To check previous system events, scroll back using the PRIOR () button.



TO ARM IN 1-4 HRS. (Not for UL Installations.)

Use this function to (a) delay programmed autoarming up to 4 hours, 15 minutes or (b) initiate autoarming in 4 hours, 15 minutes as follows. **Note:** Autoarming may not be used in UL installations.

At the "AUTOARM IN 1-4HR" display:

For 1hr, 15min delay: press the button, then the button.

For 2hr, 15min delay: press the button, then the button.

For 3hr, 15min delay: press the button, then the button.

For 4hr, 15min delay: press the button, then the button.

Fifteen minutes prior to arming, the siren will sound a 2-second warning and the keypad will begin a 15-minute countdown with the sounder pulsing. (The sounder may be silenced by pressing the button, but it will come back on one minute before arming.) Within this countdown window, arming may be delayed an additional 1 to 4 hours, as above, or autoarming may be canceled by arming and disarming the panel.

DISPLAY AUTO ARM SCHD (Not for UL Installations)

Press YES () button to display the autoarm schedule programmed by the PCD3000 software. Use NEXT () and PRIOR () button to scroll forward and back through the week. While the programmed schedule cannot be changed at the keypad, autoarming may be delayed up to four hours at the keypad, or it may be totally disabled, up to one week in advance. Select the day using the NEXT () and PRIOR () buttons. Then select the delay (1-4 hours) or disable using the button. Fifteen minutes prior to autoarming, the siren will sound a 2-second warning and the keypad will begin a 15-minute countdown with the sounder pulsing. Within this countdown window, arming may be delayed an additional 1 to 4 hours (using TO ARM IN 1-4HRS function), or autoarming may be canceled by arming and disarming the panel.

ACTIVATE PROGRAM

At Keypad No. 1, press YES (the) button to activate the User Program (Program-1) Mode or Dealer Program (Program-2) Mode, depending upon the code entered. Scroll through the programmable functions using NEXT (the) button) and PRIOR (the) button). To exit this mode at any time, press . **Note:** Keypad No. 1 may be located in any area.

ACTIVATE DOWNLOAD

Used on-site for remote downloading of a control-panel program from the PCD3000. Press YES (the) button to initiate the data transfer.

DISPLAY RF XMITTER STAT

Press YES (the) button) to check the status of up to 96 transmitters. The keypad will display:

- ✓ zone number (Z01-Z96)
- ✓ transmitter ID code number (6 digits)
- ✓ point number (PT1-PT4; "9" for unsupervised)
- ✓ status of transmitter:

NODATA: transmission not yet received

NORMAL: transmitter's zone normal;

FAULT: transmitter's zone open;

LOBATT: transmitter battery low;





TAMP: transmitter case open;

S.FAIL: supervisory failure (test transmission not received within programmed time);

✓ relative signal strength of the last transmission, on a scale of 1-10 (10 being the strongest). (“SS—” indicates transmission not yet received.) **Note:** A signal strength of 3 or less is an indication that reception may be unreliable.

In such cases, the use of an additional receiver located closer to the transmitter is recommended. If two receivers are connected to the GEM-P9600, only the higher signal strength of the two will be displayed.

RELAY CONTROL

Press YES () to check the status (all on or all off) of up to 8 groups programmed with any combination of up to 96 available external relays. The group number will display with a related description. Scroll through the groups using the NEXT () and PRIOR () buttons; change the status of the displayed group by pressing the  button.



KEYPAD MESSAGES

The GEM-RP1CAe2 Keypad can display the following messages. The GEM-RP2ASe2 and GEM-RP3DGTL will display similar abbreviated messages that may scroll through two screens.

KEYPAD MESSAGES

SYSTEM READY CW1 - All zones operating; system can be armed. GEM-RP1CAe2 only: C = Chime Mode on; W = Watch Mode on; 1-8 = Area.

PLEASE WAIT - Panel reporting to central station on arming. Wait for ringback signal to exit.

EXIT TIME XXX SI1 - Exit delay in progress. XXX = exit time remaining in 10-second decrements; GEM-RP1CAe2 only: S = Service Code active; I = arming with Instant protection; 1-8 = Area.

ENTRY TIME XXX - Entry delay in progress. XXX = entry time remaining in 10-second decrements.

SYSTEM ARMED SI1 - Panel armed. GEM-RP1CAe2 only: S = Service Code active; I = arming with Instant protection; 1-8 = Area.

CHECK STATUS CAW - One or more zones not secured. Display status for zone description(s). GEM-RP1CAe2 only: C = Chime Mode on; W = Sensor Watch Mode on

CAN'T ARM/ZONES NOT NORMAL - Arming attempted with Priority Zone in trouble. Secure zone to arm.



DAY ZONE TRBL - Trouble condition on Day Zone, followed by one or more zone descriptions.



INVALID ENTRY/TRY AGAIN - Wrong code/time/area number entered.

CAN'T ARM SYSTEM - Arming attempted with System Trouble present. Press the  button and then arm the system.

ALARM - Alarm condition, followed by one or more zone descriptions.

******FIRE****** - Fire alarm condition, followed by one or more zone descriptions.

FIRE TROUBLE - Trouble condition on a Fire Zone. Press  button to silence the sounder. Correct the trouble, then press the  button again.

FIRE ALARM - Alarm condition on a Fire Zone. Press the  button to silence the sounder. Correct the cause of the alarm, then press the  button again.

ZONES BYPASSED - (When Zones Bypassed displayed) Indicates zones that have been deactivated.

OV(R-) - Overview Mode (Status of up to 8 areas): R=Zone Ready; also, Z=Zone Fault; A=Armed; B=Burglary Output; F=Fire Alarm; T=Fire Trouble; C=Check Trouble; Display Mode.

SYSTEM TROUBLE - A System Trouble display will be followed by one or more of the following error codes:

E01-00 - AC POWER FAIL. Power failure. Check power transformer. Check for blown fuse or circuit breaker; general power outage.

E02-00 - LOW BATTERY. Battery below 11 volts. If not recharged within 24 hours, replace it.

E03-00 - COMM FAIL. Unsuccessful communication to central station. **Note:** Will also display if panel improperly programmed to report; i.e., Report Alarm, Report Codes, Subscriber ID Numbers, etc. must be programmed.

E04-NN - WL TRBL. Wireless transmitter supervisory failure. NN = transmitter number.

E05-NN - WL LOBATT. Rf transmitter low battery. NN = transmitter number.

E06-NN - RF REC TROUBLE. Rf receiver response

trouble. NN = receiver number.

E07-00 - DOWNLOAD FAIL. Download failure.

E08-00 - TELCO LINE1 FAIL. Telephone line failure (system trouble displays after a programmed delay).

E09-00 - NOT PROGRAMMED. System cold start.

E10-NN - BURG KEYPAD TRBL. Keypad response failure. NN = keypad number.

E11-NN - BURG KPD TAMPER. Keypad cover removed. NN = keypad number.

E12-NN - BURG EZM TRBL. Expansion zone module failure. NN = module number.

E13-NN - BURG EZM TAMPER. EZM module cover removed. NN = module number.



E14-NN - RELAY BOARD TRBL. Relay board response failure. NN = relay board number.

E15-NN - WL TAMPER. Transmitter cover removed. NN = transmitter number.

E16-NN - RF REC JAMMED. Receiver jammed. NN = receiver number.

E17-NN - RF REC TAMPER. Receiver cover removed. NN = receiver number.



E18-NN - LOBATT KEYFOB. Key fob transmitter low battery. NN = key fob transmitter number.

E19-00 - USER MEM ERROR. Internal memory error. Select RESET SYSTEM TBL. Press the  button, then the  button.

E20-00 - DEALER MEM ERROR. Same as above.

E22-NN - PIR SENSOR TRBL. No trip detected on PIR Supervision Zone within programmed Sensor-Watch time. NN = Zone number. To reset, press YES () button at "RESET SENSOR MSG" function display.

E23-00 - BURG BUS FAILED. Failure of 4-wire bus. Check Terminals 11/12.

E24-00 - TIME FOR SERVICE. A service message can be programmed through the PCD3000 Quickloader (event-schedule screen) to remind the user to arrange for scheduled maintenance. At the programmed date and time, the keypad sounder will start to pulse and the display will read "TIME FOR SERVICE" (GEM-RP1CAe2) or "SERV" (GEM-RP2ASe2). This condition will behave as a system trouble and may be cleared as such, i.e., press  to silence sounder; access RESET SYSTEM TRBL, then press the  button.

E39-00 - RF CAPACITY TRBL. Receiver capacity error.

E51-00 - Alarm Output Supervisory.

E99-00 - Keypad panic shorted too long. GEM-RP2ASe2 / GEM-RP3DGTL only.

NN OUT OF SYSTEM - Keypad inoperative. NN = keypad number.

ALARM - (After panel is disarmed) displays zones violated.

FAULT FIND - Fault-find Mode activated.

LOCATE - Locate Mode activated.



GLOSSARY

Note: Displayed messages shown are for the GEM-RP1CAe2 keypad. GEM-RP2ASe2 and GEM-RP3DGTL messages are similar but abbreviated. Refer to the GEM-P9600 Programming Manual (WI777) for address numbers.

Abort Delay (Do not program for UL Applications.)

A delay period that allows cancellation of the central-station report by disarming the control panel. Program zones for Abort Delay; see Time Selection for delay time.

Note: If Abort Delay is selected for a 24-Hour Zone, the zone must be cleared before disarming the area.

Ac Failure

Ac-Fail Report Delay

If AC power is removed from the control panel, "E01-00 AC POWER FAIL" will display at the keypad with a flashing "SYS/TRBL" reminder and a pulsing sounder. Press the **RESET** button to silence the sounder; the "SYS/TRBL" as a reminder will remain on and "SYSTEM READY" will appear in the display. If a User Code is entered within 5 minutes, the panel may be armed successfully. After 5 minutes, the system trouble will again display.

Ac Failure may be programmed to activate the burglary output or any external relay, and/or report to a central station (program Panel AC-Fail Report). An alarm and/or restore report to the central station will occur immediately unless an Ac-Fail Report Delay is programmed (see Time Selection). Ac Failure is logged immediately upon detection.

Access Control

Access Control (Panel Access) on Auxiliary Output

Auxiliary Output Access Control Time

Keypad Access

Access Only

Access Logging

Note: The GEM-P9600 has not been evaluated by UL for compliance with UL294 (Access Control Systems).

If *Access Control on Auxiliary Output* is selected, entering the Access Code while disarmed will trip the panel's Auxiliary output. This is commonly used to activate a door strike for the purposes of remotely unlocking a door. Each keypad is individually selected for Panel Access (see Keypad Features). Also program *Auxiliary Relay Access Control time* (see Time Selection). **Note:** Do not program the Auxiliary Relay as an output on alarm.

Keypad Access is selectable for any keypad 1-8 by appropriate programming of the Keypad Access Byte (see Access-Control Keypads herein and User Codes, Authority Levels & Keypad Access Control Byte in the Programming Workbook, WI777). However, if the Keypad Access Byte is programmed, the code will no longer function as an Arm/Disarm Code. It will then display "ENTER CODE" and will no longer be capable of arming or disarming.

Entering a valid code at the keypad will cause a 5-second output on the keypad's PGM line with a pulsing sounder and the display "**ENTER NOW**" (or other customized message). If Access Logging is programmed, keypad access control will be added to the event log, by keypad.

An RB1000 Relay may be used to activate a door strike. Power to the door strike should be supplied from an independent source.

Access, Garage Door Opener Control by KeyFob.

The Auxiliary Output can be programmed to activate by KeyFob, providing access functions such as opening and closing a garage door, or remotely activating an electric door strike. This is achieved by programming *Access on Aux. Output*, into the Aux. 1 or Aux. 2 option locations on the Wireless KeyFobs screen. This feature also requires a valid time to be entered into the *Auxiliary Relay Access Control time* in the Time Selection Screen.

Access Number for Outside Line

Some subscribers will have a telephone system that requires one digit to access an outside line. The first dial tone encountered (prior to the access number) may have a frequency that is different from that of the accessed dial tone (440Hz). One or more 4-second Pre-Dial Delay "D"s may be entered before the access number instead of a dial tone with frequency "E". See Pre-Dial Delay; Telephone Numbers. (**Note:** The panel features automatic dial-tone detection and will normally not require any "E"s. To disable this feature, program an "8" in Address Location 4084.)

If the subscriber's system uses an access number, contact the telephone-equipment supplier to find out if a dial tone other than 440Hz is received prior to dialing the access number. If the communicator must delay before dialing the access number instead of attempting to recognize the dial tone, find out how many 4-second delays must be programmed.

Alarm on Day Zone See Day Zone



Alarm Outputs (See Wiring Diagram for UL requirements.)

The GEM-P9600 has three Form-C relay outputs: Burglary, Auxiliary and Reset. Each has a related jumper (B, A, and C, respectively) that may be cut for dry contacts.

The following table summarizes wiring for signalling an alarm in typical installations. See Time Selection for timeout duration.

OUTPUT	NORMAL OPERATING OUTPUT VOLTAGE TERMINALS	WET CONTACT TERMINALS ⁽³⁾			JUMPER ⁽⁴⁾
		COM	N/C	N/O	
Bell Output (Burg.) ⁽¹⁾	5(+) & 14(-) ⁽²⁾				
Bell Output (Pulsed)	5(+) & 14(-) ⁽²⁾	3	4	5	B
Aux. Relay	8(+) & 14(-)	6	7	8	A
Reset Relay (Fire Verification)	28(+) & 14(-)	E22	28	15	C ⁽⁵⁾

U.L. INSTALLATIONS:

- ⁽¹⁾ For Residential Fire, cut jumper PS and install jumper JP6.
- ⁽²⁾ Combination Residential Burglary/Fire systems require distinctly different signals for burglary and fire; for Single Bell, program "Burg. Output" for burglary zones and "Pulsed Output" for fire zones.
- ⁽³⁾ Aux., Burg. and Reset Relays provide wet contacts (positive voltage on COM, N/C and N/O contacts); for negative (-) connection.
- ⁽⁴⁾ Cutting the Aux., Burg. or Reset Relay associated jumper will provide Dry Contacts (no voltage on COM, N/C and N/O contacts); for use with external power supplies and/or loads (see wiring diagram).
- ⁽⁵⁾ Removal of Reset Relay Jumper C will remove power to all smoke detectors, if any are installed.

See Time Selection for timeout requirements.

OUTPUT	WIRING	REMARKS
Fire Lug	E9(-)	See Fire Lug
Reset Output (Smoke Reset)	28(+) & 29(-)	To Smoke Power Relay

Alarm; Alarm Restore Telco 1/Telco 3 See Report Telco 1/Telco 3

Alarm; Alarm Restore Telco 2 See Backup Report on Telco 2

Ambush

A two-digit code that is entered immediately prior to (and as part of) the regular Disarm Code. This will cause a silent report to be sent to a central station. Thus, should a user be forced to disarm, he can silently signal an emergency while appearing to be merely disarming the system. The Ambush Zone will automatically report, when programmed, to report on alarm.

To program, (a) program Ambush to report on alarm; (b) enter two digits as the Ambush Code; and (c) enter an Ambush-Zone Alarm Report Code. Each keypad is enabled for Ambush individually (see Keypad Features).

Inform the user what the Ambush Code is, and that his Arm/Disarm Code must be entered less than 10 seconds after the Ambush Code for an ambush report to be sent.

An Ambush code should not contain digits used as the first two digits of any user code.

Answering Machine Pickup Without Line Seizure See Callback-Method Download

Anti-Jam Time

If the communicator does not detect a dial tone within 12 seconds, the Anti-Jam feature will be activated. That is, the communicator will go off line for a 16-second anti-jam interval in order to free the telephone circuit from an incoming call, then make another 12-second attempt at dial-tone detection. If still unsuccessful, the communicator will again go off line for 16 seconds, then proceed to dial anyway.

Areas**Zone Area 1-Zone Area 8****Priority Area Arming**

Although the default program will automatically set up Zones 1 through 8 for Zone Area 1, the panel may be partitioned into eight areas. Each zone must be assigned to at least one area. At least one zone must be assigned to Area 1. If a burglary zone is selected for both areas, that common zone will not arm until both areas are armed. If any zone disarms, the common zone will disarm.

In a multiple-area system, be sure to also program:

- Enable User Code by Area (see User Codes/Authority Levels);
- Keypad Area Assignments
- Bell Control (determines which bells an area may silence);
- Subscriber Opening/Closing ID Numbers and Event ID Numbers (if reporting);
- System Trouble Subscriber ID Number

If Priority Area Arming is selected, the Priority Area must be armed before the Arming Area can be armed.

Arm Lug (Lug E4)

Lug E4 (ARM) will go to approximately 1Vdc when all areas in the system are armed. This lug may be used for auxiliary equipment. (For use, refer to the instructions furnished with the device.)

Auto Bell Test on Arming (Required for UL Mercantile installations.)

This will activate the Burglary Output briefly 10 seconds after the area is armed. If the alarm does not sound, the device may be defective.

Auto-Bypass (Do not program for UL installations.)**Auto-Bypass Re-entry**

Zones programmed for Auto-Bypass will be bypassed (automatically removed) if in trouble when arming. A momentary beep will sound at the keypad to warn that the system has been armed without the protection of the auto-bypassed zone. (Note that the exit/entry door must be closed before arming, otherwise the Exit/Entry Zone will be auto-bypassed.) **Note:** A zone in trouble that is not programmed for Auto-Bypass will cause an alarm on arming after a 10-second arming delay.

If Auto-Bypass Re-entry is selected, securing a zone that is programmed for Auto-Bypass, while armed, will cause that zone to re-enter the system in an armed state.

Auto Disarm Rearm Delay

If the panel was auto-disarmed on schedule and a rearm delay is programmed (see Time Selection), the panel will automatically rearm after the delay if no activity has been detected.

Automatic Interior Bypass

Interior 1 Normally Bypassed must also be programmed for this feature to work. This feature will cause all Interior-1 Zones to automatically provide protection if the Exit/Entry doors are opened during the exit-delay period. If the  button is pressed while armed, exit delay will restart and the Exit/Entry doors may be opened to permit someone to exit (while others remain on the premises) without causing an alarm.

Aux. Output Chirp on Key-Fob Arming

This feature will cause a 1-chirp indication on arming and 2-chirp indication on disarming. Connect steady input (burglary) of external siren driver to the panel's Auxiliary Alarm Output. **Note:** Do not use an external voice siren driver.

Auto-Reset**Auto-Reset After Burglary Output Timeout**

If a zone detects an alarm condition and is selected for Auto-Reset, it will automatically rearm itself as soon as the alarm condition is cleared. Auto-Reset may be delayed to occur after the Burglary Output timeout period by selecting Auto-Reset After Burglary Output Timeout and Auto-Reset. Zones that are not programmed for Auto-Reset will not be capable of signalling another alarm until (a) the cause of the alarm has been corrected and (b) the control panel is disarmed. Also see Swinger Shutdown.

Auxiliary Relay See Alarm Outputs**Backup Report on Telco 2**

If Backup Reporting is selected and the communicator does not reach the first telephone number after two attempts, seven attempts will be made to reach the second telephone number. Enter Subscriber Identification Numbers for Telephone 2 and other information required for Telephone 2. Also program Backup Report on Telco 2. Any zone programmed to report to Telco 1 will backup report to Telco 2. **Note:** Subscriber Identification Numbers for both Telephones 1 and 2 must be entered, even if they are the same

Battery

12Vdc standby power source in the control panel is used to provide backup protection in the event of a power loss. The battery is an integral part of the system and must be installed, even if ac power is present. Change the battery every 5 years or as required.

Bell Control

In any system, the ability to silence any combination of alarm devices (outputs) initiated from any area. Bell Control must be programmed for all systems to be able to silence an alarm. For example, in a two-area system, each area could be programmed to silence only those alarms initiated within its own area; or both areas could be programmed to silence an alarm initiated from either area.



Blocked View Option for User Codes

User codes can block another code from being viewed by another user. An unblocked code cannot view a blocked code, but a blocked code can view all codes. The master user code and the dealer program code can view all codes.

Burglary Lug (Lug E10)



Lug E10 (BURG.) will go to about 1Vdc when the Burglary Output is tripped. This lug is intended for connection to UL-listed devices rated 5mA maximum and capable of operating over the voltage range of 8-13.0Vdc (12V, special application). Use Napco Part No. WL1 for connection.

Burglary Output See Alarm Outputs

Bus Failure

Communication failure on the 4-wire bus will cause a system trouble and a report to the central station. Program System Trouble Reports and Report Codes for the 4-Wire Bus.

Bypass Faulted Zones

If programmed, pressing the  and  buttons simultaneously will bypass all zones in trouble (except Fire and PIR Zones) that are also programmed for Selective Bypass. The message, "BYPASSED ALL ZONE FAULTS" will display.

Call Waiting See Disable Call Waiting

Callback-Method Download**Answering Machine Pickup Without Line Seizure**

Disable Callback Download (Required for UL installations)

Disable Answering Machine Download (Required for UL installations)

Disable Function-Mode Download**Number of Rings Before Pickup**

Data may be downloaded remotely to the panel after a programmed number of rings (3 to 15) and a control-panel confirmation callback. Program the number of rings; if not programmed, the panel will pick up after 15 rings.

This method will accommodate an answering machine at the site. (Disable Answering Machine Download must not be programmed.) The answering machine will pick up on its programmed number of rings, as usual. The panel will then listen for the signal from the PCD3000 software and seize the line from the house phones as well as the answering machine and the connection will subsequently be established. **Note:** The number of rings programmed into the panel must exceed that of the answering machine.

Program Disable Callback Download to prevent unauthorized downloading to an unattended panel. Program Disable Answering Machine Download to inhibit downloading to a telephone connected to an answering machine. Program Disable Function-Mode Download to prevent downloading at the keypad.

Cancel Next Test Timer Report on Any Report See Test Timer**Cancel; Cancel Code; Cancel Report to Telco 3; Cancel Window Duration**

CANCEL is the preventing of a report from being sent by entering a user disarm code. If the area is disarmed during the "Pre-Alarm Warning", then no report will be sent and no messages will be displayed at the keypad. If the area is disarmed during the Abort-Delay, then an "Alarm Canceled" will be displayed at the keypad and no report will be sent. If the area is disarmed during or within the Cancel Window Duration, then an "Attempting to Cancel" will be followed by an "Alarm Canceled" for a successful cancellation. Otherwise, the report had been sent and will be responded appropriately to by the Central Station. Cancel must be provided with a Central Station Telephone Number, proper Subscriber ID Numbers and a valid Cancel Code to Telco 3. A Cancel Window is the duration that the system will attempt to cancel a report, after the report is sent.

Chime (Displays "MONITOR" on GEM-RP2ASe2 Keypads)

This annunciator feature may be used on any zone to sound a tone at the keypad while disarmed when the zone is faulted. Access the ACTIVATE CHIME function to enable or disable the Chime Mode from the keypad. This feature is programmable by zone and for duration of tone (see Time Selection). A time (in ¼ seconds) must be programmed for the chime to function.

Chime 2 (Displays "MONITOR" on GEM-RP2ASe2 Keypads)

For a distinct pulsating "Chime Zone" tone, program the zone for Chime 2. This feature allows zones to have distinctive annunciator chime to identify the door(s) or zone(s). "Chime" must be activated on any keypad for all area keypads to chime.

Chime on E4 Lug

The E4 Lug can now serve as an output that follows the chime sounder. This can be used where a remote sounder is needed to follow the keypad sounder. This feature can be found on the Options page of the PCD software, or you can program a bit value of 2 in the right hand side of location 2420 [•] [2].



“Clean Me™” Smoke Detector Support

A new option "Enable Smoke Detector Dirty Trouble" will enable support of the Sentrol ESL 521 series Smoke Detector CleanMe™ self diagnostic feature. The Smoke Detector will signal the control panel when the detector needs to be cleaned, or when the sensitivity falls below an acceptable level; which will cause a report to central station as well as a trouble condition at the keypad.

Clear Program

Caution: Erases the dealer program. Use this feature to start a new customized default program. Access Location 4091, then press the  button.

Closing Report**Closing Report Only on Conditional Closing****Conditional Closing****Include Selective/Group Bypass In Conditional Closing/Status****Status Report**

On arming, the communicator can transmit a unique Closing Code for each user and a status report that identifies the problem zone to the central station. Note that Subscriber Identification Numbers and a Closing Code must be entered for any closing report.

Select which users will report closings for each telephone number, even if Closing Report Only on Conditional Closing is selected. Normally, a closing report will consist of the Closing Code and the number of the user that armed. If the user armed with an auto-bypassed zone (or selective/group bypassed zone if Include Selective/Group Bypass In Conditional Closing/Status was programmed), the Conditional Closing Code will also be sent.

Select Closing Report Only on Conditional Closing to report only when arming with an auto-bypassed zone (and selective-/group-bypassed zone if Include Selective/Group Bypass in Conditional Closing/Status is programmed).

Select Status Report to send a closing followed by a status report that identifies the problem zone(s). A typical Status Report is represented by the following example.

Example (4/2 Format). A burglar breaks into a commercial establishment during the night, breaking the window foil on Zone 5. The Open/Close Subscriber Identification Number is "1234"; the Alarm Code for Zone 5 is "3,5" (Burglary Zone 5); the Subscriber Identification Number is "6789"; the Closing Code is "C". The communicator will send the following report to the central station.

When alarm occurs:

"6789 35" - Alarm, Zone 5

Closing Report:

"1234 C1" - Closing, User 1 (User 1 returned, inspected damage & rearmed; the same transmission would occur for User 11, 21, 31, etc.)

"1234 F5" - Trouble, Zone 5 (zone status at time of closing: Window foil still broken; Zone 5 auto-bypasses, repair required; the same transmission would occur for Zone 15, 25, 35, etc.)

Cold Start

Caution: Erases the entire program (codes, schedules, etc.), leaving the panel as it came right out of the box. Access Location 4093, then press the  button.

Data Format

Ask the central station which of these formats to use.

Two-Digit or 4/2 Format. Some central-station receivers require that a four-digit Account Code followed by a two-digit Alarm Code be sent in each report. Example. In a certain installation, the Alarm Subscriber Number is "1234"; a burglary alarm occurs on Zone 1. The Alarm Code for Zone 1 is "3". The communicator will send "1234 31" (Account No. 1234; Alarm, Zone 1).

1400Hz Handshake/Kissoff. 1400Hz Handshake overrides 2300Hz Handshake if both are selected.

2300Hz Handshake/Kissoff. Used with the following receiver formats: Radionics, DCI & Franklin Slow; Radionics Fast; Sescoa, Vertex, DCI & Franklin Fast; Radionics BFSK. 1400Hz Handshake overrides 2300Hz Handshake if both are selected.

Zone Number on Pulse Alarm. If selected, an Alarm Code need not be programmed (the zone number will replace the Alarm Code), however codes for restore, trouble, etc. are still required. Thus, in the foregoing example, if "E" is the designated Restore Code, and Zone 24 trips and is restored, the communicator will send "1234 24" (Account No. 1234; Alarm, Zone 24) followed by "1234 E6" (Account No. 1234; Zone 24 Restored).

Single-Digit Event Code Format. The single digit sent for a particular event can be either the Event Code or the units digit of the zone number.

Sum-Check Format. Sum Check is a sophisticated data format used to enhance the speed and check the accuracy of the received transmission. This format should be preferred whenever the central station is capable of receiving it. After transmitting the Subscriber Identification Number and the Alarm Code, the communicator sends a verifying digit that is the sum of both. The receiver compares the verifying digit with the sum of the other numbers to check transmission accuracy.

3/1 with Extended Restores. Some receivers require a three-digit Account Code followed by a single-digit Alarm Code. Example. In another installation, the Alarm Subscriber Number is "123"; an alarm on Zone 1 is restored. The Restore Code for Zone 1 is "E,1". The communicator will send "123 E" (Account No. 123 Restored); followed by "EEE 1" (Restored, Zone 1).

Modem Formats. Modem formats (SIA, Point ID, Express, 4/3/1, Modem 2) are preset and automatic but require a Type for each zone. Program Zone Type as follows: Fire* = "1" (Note: Not for Modem 2 Receivers); Panic = "2"; Burglary = "3"; Holdup = "4"; Gas Alarm = "7"; Heat Alarm = "8"; Auxiliary Alarm = "A" (Keypad displays "0"); 24-Hour Aux. Alarm = "B".



Pager Formats. The control panel has provisions for dialing a pager phone number. The panel will wait for ringing, wait for silence, then send its data. Caution: Because there is no handshake/kissoff, this feature should only be used for Double Reporting; it may not be used for Backup Reporting. Only one report is sent for any call. Pager digits are limited to "0" through "9". Digits represented by "A" through "F" will be converted to "0"s for transmission purposes. Pager formats are 10 digits, arranged as illustrated by the following examples.

Alarms, restores, etc. are transmitted in a 3-3-4 arrangement representing Report Code, Descriptor and Account Number.

Example 1. Burglary, Zone 22 (Report Code = "3".)

Transmits: 003 022 1234, where

003 = Report Code (always two zeros + programmable Report-Code digit, 0–9);

022 = Descriptor (always one zero + 2-digit descriptor, zone number: 01–96);

1234 = Account Number (4 digits, programmable).

Openings, closings, etc. are transmitted in a similar arrangement

Example 2. Closing, User 12 (Closing Code = "8")

Transmits 008 012 1234, where

008 = Report Code (always two zeros + programmable Opening/Closing digit, 0–9)

012 = Descriptor (always one zero + 2-digit descriptor (user number: 01–96);

1234 = Account Number (4 digits, programmable).

Keypad Report Codes and System Report Codes are transmitted in the same format.

Pager - Programmable Number of Resends of Report Program the number of resends to allow the panel to send multiple reports of same signal to insure that signal is received by pager.

Pager - Maximum number of reports per session. Program the maximum number of Pager reports to be sent per session.

Pager (Telco 3) Report Delay Programmable delay of the Telco 3 report (typically used for Pager Reporting) intended to allow time for central station to allow to verify alarm report the alarm report.

Compatible Receivers. The following receivers are compatible with the GEM-P9600.

- **FBI CP220.** Formats: Ademco Slow; Silent Knight Slow; Silent Knight Fast; Sescoa; Vertex; DCI; Franklin Slow; Franklin Fast; SIA; Radionics Slow; Radionics Fast; Radionics BFSK; FBI 4/3/1; Universal High Speed.
- **Ademco 685.** Formats: Ademco Slow; Silent Knight Slow; Silent Knight Fast; Sescoa; Vertex; DCI; Franklin Slow; Franklin Fast; Radionics Slow; Radionics Fast; Radionics BFSK; Universal High Speed; Ademco Point ID; Ademco Express.
- **Radionics 6500.** Formats: Ademco Slow; Silent Knight Slow; Silent Knight Fast; Sescoa; Vertex; DCI; Franklin Slow; Franklin Fast; Radionics Slow; Radionics Fast; Radionics BFSK; Universal High Speed; Radionics Modem 2.
- **Osborne-Hoffman Quickalert.** Formats: Ademco Slow; Silent Knight Slow; Silent Knight Fast; Sescoa; Vertex; DCI; Franklin Slow; Franklin Fast; SIA; Radionics Slow; Radionics BFSK; Universal High Speed; Ademco Point ID; Ademco Express.
- **Silent Knight 9000.** Formats: Ademco Slow; Silent Knight Slow; Silent Knight Fast; Sescoa; Vertex; DCI; Franklin Slow; Franklin Fast; Radionics Slow; Radionics Fast; Radionics BFSK; Universal High Speed; SIA.

Day Zone(Open; Short)

Alarm on Day Zone

Disable Auto-Reset on Day Zone

Reset Day Zone with Arm/Disarm Only

Enable Watch, Areas 1-8 (By Area)

A Day Zone will give an audible and visual indication at the keypad if there is a problem on the loop while disarmed. Open- and short-circuit conditions are programmed separately, by zone. This feature may be used to warn of a problem (a break in a window foil, for example) during the day, when the panel is not normally armed. When the Day Zone is tripped, "DAY ZONE TRBL" and the zone number(s) will alternately display at the keypad and the sounder will pulse. Press the **RESET** button to silence the sounder and reset the keypad. "ZONE FAULT" will be displayed until the condition is corrected. If Reset Day Zone With Arm/Disarm Only is programmed, arm and disarm the panel to reset the Day-Zone indication at the keypad.

If Alarm on Day Zone is programmed for a zone, a Day Zone condition will cause the alarm outputs programmed for that zone (sirens, relays) to activate.

Note: (1) If a zone is programmed for both Day Zone Open and Day Zone Short, either condition must be reset before the other can activate. (2) Day Zone Short will not function if No EOL Resistor is also programmed.

Report Trouble or Trouble Restore is programmed in conjunction with Day Zone Open/Day Zone Short and Trouble on Open/Trouble on Short (the trouble reported will be that programmed under Day Zone Open and/or Day Zone Short).

Note: Do not program a Day Zone for 24-hour protection. The keypad will annunciate as a Day Zone but the panel will transmit an Alarm Code and a Trouble Code when tripped.

Program Disable Auto-Reset on Day Zone to prevent repeated Day-Zone trips. This will cause the keypad display and sounder to activate only once in any arm/disarm period.

If Enable Watch is selected (by area), zones programmed for Day Zone can only be activated when ACTIVATE WATCH is accessed. Arming and disarming will turn off the Watch Mode. If Report Trouble is selected, a trouble on a Day Zone will be reported only when the Watch Mode is on.

Dealer Security Code See Master Security Code



Dial-Tone Detection**Disable Auto Dial-Tone Detection**

The panel features automatic dial-tone detection to ensure that a dial tone is present before the communicator dials. To disable this feature, program an "8" in Location 4084.

When an "E" is programmed before the first digit of an outside telephone number, the communicator dial-tone detection circuit is set to detect the standard 440Hz dial tone. The "E" is generally entered in the location immediately preceding the telephone number.

It may be necessary to program at least one 4-second pre-dial delay before a dial-tone detection "E". With certain nonstandard exchanges, pre-dial delay "D"s may be used without a dial-tone detection "E". (See Access Number for Outside Line; Pre-Dial Delay; Telephone Numbers.)

Digital Dialer Test

Activating the digital dialer test from the Function Menu (ACTIVATE DIALER TEST) will send the programmed report code to the central station. Program DD TEST for SYSTEM-TROUBLE REPORTS and enter a DD TEST Report Code. Note that in this case the report code received is not indicative of a system trouble, but is an indication of a successful transmission. Should the transmission fail, the keypad will display "E03-00 COMM FAIL". This system trouble may be reset by pressing the  button. Any successful subsequent report will also clear the system trouble.

Disable Answering Machine Download See Callback-Method Download

Disable Auto-Reset on Day Zone See Day Zone

Disable Auto Status

Non 24-Hour Zones that are open (or shorted) normally display "ZONE FAULTS" (while disarmed) followed by the zone number(s) and description(s). In high-security applications, program Disable Auto Status. Unsecured zones will then be indicated by a "CHECK STATUS" display. Status may be displayed manually using the DISPLAY STATUS function, however a valid user code will be required.

Disable Auto-Unbypass on Disarming

Normally, manually bypassed zones revert to active (disarmed) zones on disarming. Select this feature to maintain bypassed zones on disarming until manually unbypassed.

Disable Call Waiting (TouchTone® Dialing Only)

A digital communicator connected to a telephone line with Call Waiting may be disrupted by this feature. However, most lines with Call Waiting also have Selective Call Waiting, which permits the feature to be turned off by dialing a "*70" just before the telephone number. A "*" will be dialed by programming a "B".

If the installation has the Call Waiting feature, be sure that it also has Selective Call Waiting, and confirm the disable code with the telephone company. Then program this code ("B70") directly before the phone numbers (after dial-tone detection or pre-dial delay) in the telephone-number locations. See Telephone Numbers.

Caution: Should the user cancel his Call Waiting service, the communicator will dial a wrong number unless the phone number is corrected.



Disable Callback Download See Callback-Method Download

Disable Code Required for Easy Bypass See Selective Bypass (Do not program in UL Installations)

Disable Code Required for Function Mode Level 1

Intended primarily for residential applications, this feature eliminates the user code requirement to access the Function Mode (for Level-1 Users only), rendering the system more user friendly.

Disable Fire Reset (by Area)

Normally, pressing the  button will momentarily remove power to the smoke detectors. If Disable Fire Reset is selected for any area, the  button will no longer activate the Reset Output so that the integrity of the smoke detector's Alarm Memory feature (LED indication) will be maintained. Also see Alarm Outputs; Smoke Detectors.

Disable Function-Mode Download See Callback-Method Download

Disable Openings/Closings

Provides the flexibility of disabling openings and/or closings from any area(s).

Disable Wait-for-Handshake/Kissoff

Causes data transmission to start immediately after the telephone number.

Disable Wait-for-Silence (Pager Format)

Causes data transmission to start immediately after the pager telephone number.

Double Reporting See Report Telco 3

Download Security Code See Master Security Code

Download To an Armed Panel

This allows the panel to accept a download even if Armed. However if the programming to be altered effects the arming profile of the control, such as zone features, it is recommended that the panel be disarmed and then rearmed to allow these changes to be processed properly. Any program changes such as adding/changing user codes, adding users to an area, or changing Entry/Exit Delays will be processed properly with the panel armed.



Don't Clear Aux. Relay with Arm/Disarm

Used in conjunction with Key-Fob Option "C" above to prevent a disarm from resetting the Aux. Relay.

"E" Lugs (E3, E5, E7, E9, E10, E11, E14, E18, E19, E22)

E9 - See Fire Lug

E10 - See Burglary Lug

E19 - See Veri-Phone: Silence All Outputs During Audio Session

E22 - Common terminal for Reset Relay. Use Napco Part No. WL1 for field wiring.

Easy Arming

Permits quick arming by simply pressing the  button. Each keypad may be individually programmed for Easy Arming (see Keypad Features). Disarming still requires entry of a valid user code. Do not program Easy Arming in UL installations. If closings are reported, Easy Arming will report as User 99.

Easy Setup for RF Only

Removes all EZMs automatically programmed in the menu-driven Keypad Program Mode. This must be the last step in the programming menu. Access Location 4090, then press the  button.

Enable Burg Output Warning On Entry

Causes the Burglary Output to "chirp" if the entry door is opened within 60 seconds after exit time has elapsed. This feature may be useful in cases where a keypad is not within audible range to remind a user to disarm if inadvertently exiting after exit delay has expired.

Enable Exit Delay Restart See Entry/Exit Delay

Enable Line Fault Test**Telco Line Test Delay**

Enable Line Fault Test will cause the panel to monitor the phone line. A failure will display as "E08-00 TELCO LINE1 FAIL". Program this system trouble to activate the Burglary Output.

If a time is entered in Telco Line Test Delay, the line will be tested for the programmed time before a system trouble is activated. A minimum of 30 seconds is recommended.

Enable Local Alarm on First Zone "AND" Trip See Zone ANDing (Do not program in UL installations.)

Enable Reporting to PC Preset

This feature allows a PC computer with Quickloader Software to function as a receiver. If programmed, all alarms sent to Telephone No. 1 will be sent to PC PRESET as well (regardless of whether or not transmissions to Telephone No. 1 were successful). PC PRESET must be in its Standby mode for this feature to operate.

Enable User Code by Area See User Codes/Authority Levels/Access Bytes

Entry/Exit Delay**Entry/Exit 1; Entry/Exit 2****Entry Relay****Enable Exit-Delay Restart**

Delays permit exit and entry through the Entry/Exit Zone(s) after the system is armed without setting off an immediate alarm. Entry delay allows the user time to enter and disarm the panel. Exit delay allows the user to leave the premises after the panel has been armed. Unless the keypad has been configured otherwise, the sounder will come on and will pulse during the last 10 seconds of entry delay to remind the user to disarm.

Two individually-programmable entry-delay times are provided to accommodate different entry zones. If two or more Exit/Entry Zones are entered in succession, the delay programmed for the last Exit/Entry Zone entered will take precedence over all others. Exit-Delay time and Entry-Delay time may each be programmed for up to 255 seconds (4 minutes). See Time Selection.

An external relay may be programmed to trip upon entry (see Programming Manual: Relay Event ID Codes, Area Entry Relays), and remain on for a programmed duration.

If the system has been armed with Exit-Delay Restart enabled, when the exit door is opened and then closed, the programmed exit delay will restart at 60 seconds. Thus, if a long exit delay is programmed, it will be reduced to 60 seconds after exiting, yet still allow reentry before entry time starts. If re-entry occurs within that 60 seconds, exit delay will restart once again (and only once again) at 60 seconds.

If re-entry occurs within 60 seconds after exit delay has expired, the alarm will sound a 2-second warning (with the entry sounder) to remind the user to disarm. (Exit-Delay Restart may be useful in reducing false alarms caused by a user who re-enters the premises shortly after exiting.)

Note: In UL installations, maximum exit delay is 60 seconds; maximum entry delay is 45 seconds. In UL Mercantile installations, maximum entry delay is 60 seconds.

Entry delay may be canceled by pressing the  button prior to arming, however it will be restored automatically upon disarming. (When armed with Instant protection, an "I" will appear at the right side of the display.)



Exit/Entry Follower

A zone programmed as an Exit/Entry Follower will ignore detection during the exit delay, and only during entry delay if the Exit/Entry Zone is entered first. Thus, detection devices (passive infrared detectors, for example) along the path between the keypad and the exit/entry door will not signal an alarm during exit/entry delay under normal conditions. However, if a device in the Exit/Entry Follower Zone detects a violation when the exit/entry door has not first been entered, there will be no entry delay and the Exit/Entry Follower Zone will go into an instant alarm.

If the panel is armed with the entry delays canceled (Instant protection), any violation on the Exit/Entry Zone or the Exit/Entry Follower Zone will cause an immediate alarm.

Expansion Zones**EZM Type****EZM PGM Armed Terminal Control****EZM Tamper** See Tamper

Zones 9–96 are expansion zones added to the basic system using expansion zone modules (EZMs). Any combination of GEM-EZM4 (4 zones), GEM-EZM8 (8 zones) and/or the 4-zone modules integral to each GEM-RP1CAe2 keypad may be used. Refer to Section 2: ADDING EXPANSION ZONES and the Wiring Diagram. Also see the instructions accompanying each module for wiring information.

Regardless of how the modules are arranged, the expansion zones are divided into consecutively-numbered groups of four. Each 4-zone module comprises one group of zones; each 8-zone module comprises two groups. Each group is assigned a number.



For each EZM group, program EZM Type (two nibbles, left and right), as follows: EZM Not Used: leave both nibbles blank (**); Burglary EZM: enter “1” in the right nibble (*1).

If EZM PGM Armed Terminal Control is programmed for the EZM module, Terminal 6 on the module will go low when the areas programmed for that module are armed. This may be used to display area-armed status (for example) on an external LED. **Note:** (1) This terminal is intended for connection to UL-listed devices rated 5mA maximum and capable of operating from 8.0–13.0Vdc (12V, special application). (2) In two-group modules (GEM-EZM8), only the lower of the two groups may be programmed.

Extended Format See Data Format**Fire****Keypad Fire**

Any zone may be programmed for Fire. Connect normally-open devices across a Fire Zone. The EOL2.2K end-of-line resistor must be installed (4-wire smoke detectors require an FT2200 relay instead of a resistor to supervise the power to the detector). A short across the zone will cause a fire alarm, which will be indicated at the keypad by a “FIRE” LCD display and pulsing sounder. An open circuit on the Fire Zone will identify a trouble and cause flashing “FIRE” LCD display and pulsing sounder after a 10-second delay. The sounder may be silenced using the  button. The LED will go off within 30 seconds after reset if the alarm or trouble is cleared. For Smoke-Detector Reset, see Alarm Outputs.

A fire condition that has not been restored will cause the zone number and description to scroll. To reset (acknowledge) the condition, enter a valid code, then press the  button.

If Keypad Fire is programmed, pressing both the  and the  keypad buttons at the same time will sound a fire panic alarm and display “*****FIRE*****” at the keypad. The Keypad Fire function is supplementary to the hardwired zones. **Note:** This feature shall not be considered a substitute for listed manual initiating devices.

Fire Alarm Verification (Not for use in California.)

Fire Zone programmed for “Fire Alarm Verification” will cause all zones to power down for 12 seconds. (All devices must be wired with + power on Terminal 28.) After this time, power is restored and a 4-second power-up time is started. Thereafter, the zone will be active again. This represents a total processing delay of 16 seconds from the time the alarm is first detected. If an alarm condition still exists at this time or reoccurs within 2 minutes, an alarm will be initiated, otherwise the zone will return to its original state. **NOTE:** A zone programmed for “Fire Alarm Verification” must be programmed as a “Fire Zone” as well.

Fire Output (Lug E9)

Lug E9 (FIRE) will go to about 1Vdc when a Fire Zone programmed for Fire Output is tripped. This lug may be used for auxiliary equipment. (For use, refer to the instructions furnished with the device.) Use Napco Part No. WL1 for connection.

Fire Output Cadence

The bell output will sound in a Temporal Cadence fashion in the event of a fire alarm. Program all Fire Zones or events to activate the PulseBurg Output, and program the Option PulseBurg output Cadenced.

Global System Troubles by Output

System troubles (Low Battery, AC Failure, etc.) can trip any output (Pulsed Burg, Auxiliary, etc.). **Note:** RF TROUBLE will report for RF Low Battery, RF Supervisory Failure or GEM-DT Self-Test Failure.

Include Selective/Group Bypass In Conditional Closing/Status See Closing Report**Interior Zones by Area****Interior Normally Bypassed****Auto Interior Bypass**

Interior zones that are bypassed (will not trip into alarm) from the system will permit freedom of movement throughout the



premises but still afford protection from intrusion through armed perimeter zones. Pressing the **INTERIOR** button prior to arming will select the Interior Zones, then arm to bypass. The next time the control panel is disarmed, all bypassed zones will automatically revert to non-bypassed (disarmed) zones. When the **INTERIOR** button is pressed, the "BYPASSED" reminder will come on.

The bypassed zones may be displayed on the keypad (see GEM-RP1CAe2 FUNCTION MODE).

If Interior Normally Bypassed is selected, all Interior Zones will always be inactive. The "BYPASSED" reminder will always display, indicating that only partial protection will be provided upon arming. To temporarily restore interior protection, press the **INTERIOR** button; the "BYPASSED" reminder will go out upon arming, denoting full protection, however Interior Zones will once again be bypassed the next time the panel is disarmed.

If Auto Interior Bypass is programmed, all Interior Zones will automatically provide protection if the Exit/Entry doors are opened during exit delay. (**Note:** Interior Normally Bypassed must be programmed.) If the **INTERIOR** button is pressed while armed, exit delay will restart and Exit/Entry doors may be opened to permit someone to exit (while others remain on premises) without causing an alarm.

Jumpers (Refer to Wiring Diagram for UL configuration.)

A: Cut for dry contacts on the Auxiliary Relay.

B: Cut for dry contacts on the Burglary Relay.

C: Cut for dry contacts on the Reset Relay.

D: Cut if using a PS3002 Power-Supply Module.

JP5: Keypad Configuration Jumper (top-right corner, above micro shield) is installed across top and center pins for normal operation. When configuring GEM-RP1CAe2 keypads, move jumper across center and lower pins.

JP6 & PS: For Residential Fire. See Alarm Outputs.

JP7: 2-Wire Fire jumpers. Select Zones 7 and/or 8 for use as either 2-Wire Fire Zones or Burglary Zones. Note: If customizing a single-area default program, Zone 8 is configured as a 2-Wire Fire Zone. In a two-area default program, Zones 7 and 8 are configured as 2-Wire Fire Zones common to both areas; be sure to move JP7 Zone-7 jumper to the 2-WF position (see Wiring Diagram).

Keypad Jumpers: GEM-RP1CAe2 (Refer to label LA1374 on the circuit board fishpaper for jumper locations and a summary of settings)

JP1: Cut to enable Keypad Tamper.

W1 & W3: Cut both to disable touchpad backlighting.

W2: Cut to disable LCD backlighting.

Keypad Jumpers: GEM-RP2ASe2/RP3DGTL (Refer to label LA1390 on the circuit board fishpaper for jumper locations and a summary of settings)

See Section 3: Configuring the GEM-RP2ASe2/GEM-RP3DGTL Keypad for jumper selection.

Key Fob Transmitters

Aux. Output Chirp on Key-Fob Arming

Burg Output Chirp on Key-Fob Arming

Don't Clear Aux. Relay with Arm/Disarm

Aux. Output Chirp on Key-Fob Arming will cause one 50 mS chirp to sound on arming and two 50mS chirps on disarming. Use the steady output of a siren driver. Do not use a voice siren driver.

Burg Output Chirp on Key-Fob Arming will cause one 50 mS chirp to sound on arming and two 50mS chirps on disarming. Use the steady output of a siren driver. Do not use a voice siren driver.

Programming a "C as the Key-Fob Aux-1 or Aux-2 option will provide the ability to toggle the Aux. Relay on or off. If there is an Aux. Relay timeout programmed, it will follow this timeout unless toggled off by the key fob. To provide key-fob-only control, program no timeout. Program Don't Clear Aux. Relay with Arm/Disarm to prevent a disarm from resetting the Aux. Relay.

Key-fob users can report openings and closings. Key fobs 1–8 report as Users 81–96, respectively.

Keyfob Zone Assignment

Keyfobs can be assigned to zones to allow individual reporting. Each of the 4 keyfob buttons can be assigned to a zone. For example, On button = point 1; Off button = point 2; A1 = point 3; A2 = point 4. Up to 96 keyfobs can be assigned to the GEM-P9600, providing multiple wireless panic buttons on a system, each reporting to the Central Station or a pager and/or annunciating on a keypad the keyfob zone number with description/location. To assign a keyfob to a zone, program the keyfob as you would a transmitter, entering the keyfob's ID code, check sum and point number at the appropriate zone.

KeyFob or Keypad Garage Door opener control

The Auxiliary Relay can be programmed to activate for a programmable period of time. This allows it to be used for access functions such as opening and closing a garage door. This is achieved through a new KeyFob option, Access control, by programming (*Access on Aux. Output*) into the Aux. 1 or Aux. 2 option locations. Also program the option Access Control on Auxiliary Output , and a time into the Auxiliary Output Access Control duration. If an Access Control from the keypad is desired, also program a Panel Access Code.

KeyFob Disarm Activates Entry Lighting

Disarming with a KeyFob can activate Remote Relays or X-10 Devices by programming the event EntryRelay Area1, or EntryRelay Area2 on the External Relay Control screen. This event will cause the programmed outputs to activate on either a KeyFob Disarm OR the opening of the Exit Entry zone while the system is armed.

Keypad Access see Access Control

Keypad Area Assignments

In multiple-area systems, assign an Area Number (“1”– “8”) to each keypad.

Keypad Features

The following programmed system features will activate only if they have also been enabled at the keypad.

- Ambush
- Easy Arming
- Access Control
- Keypad (Police) Panic
- Keypad Auxiliary Panic
- Keypad Fire Panic
- Keypad Panic See Panic Zone

Keypad Panic See Panic Zone

Keypad Sounder on Alarm

If a programmed zone goes into alarm, the keypad sounder will activate and will remain activated until the **RESET** button is pressed or the system is disarmed.

Keypad Tamper See Tamper

Keyswitch Arming

The area will arm/disarm when the programmed zone is momentarily shorted (momentary keyswitch). To supervise the keyswitch, program the zone for Day Zone on Open.

Leading Digits for Pager Format

In Pager Format reporting, the message typically begins with 00. With some pager services, this will cause the Pager's Voice Mail feature to activate. Program these digits to any number desired. Typical Pager report - 003 022 1234, where 3 is the Event, 22 is the zone, and 1234 is the Subscriber ID number.

If the Leading Digits are programmed as 98 (1st digit = Address Location 0520 [●] [9], 2nd digit = Address Location 0521 [●] [8]), the Pager report will now appear as 983 022 1234.

Line-Reversal Module, M278

The Line-Reversal Module allows the panel to be monitored by a central station through leased lines. On alarm, the module reverses normal line-voltage polarity. For details, refer to the instructions furnished with the module.

Logging of Security Bypassed Zones

The panel will log by User, Date, Time, and Zone any zones which are bypassed with the Security Bypass Mode. This is useful in a system where openings are on 24 hour protection zones and access is only allowed if the zone is Bypassed by an authorized User, and then Unbypassed when done. A typical application would be a warehouse or shipping terminal where the overhead doors are programmed for 24 hour protection and must be Bypassed to allow access, and then Unbypassed again.

To activate this feature, DO NOT program *Disable Code Required for EZ Bypass* is Program BE (Bypass Enable) for each user who is to have this ability.

-  To Security Bypass a zone:
1. Enter Arm/ Disarm code * Code must be Bypass Enabled
 2. Press the **BYPASS** button. The display will read, “BYPASS ENABLED”.
 3. Press the **BYPASS** button, again.
 4. Enter the zone #. The display will read, “BYPASSED ZONE ##”
 5. To bypass another zone, repeat steps 3 and 4.

-  To Security Unbypass a zone, follow the same procedure. When the zone # is entered (step 4), the display will read “UNBYPASSED ZONE ##”.

-  To Arm/Disarm the system without altering the state of Bypassed zones, program the option *Disable Auto-Unbypass on Disarming*. (Address Location 2417 = [4][●])

- ✓ It is not possible to Bypass/Unbypass Zones using the Directory Mode procedure.
- ✓ Typically, any zone, other than a fire zone, will automatically be unbypassed when the panel is disarmed. In order to unbypass a fire zone, follow procedures 1 through 4. After executing step 4 the display will read - Unbypassed, Zone #.
- ✓ When a fire zone is bypassed the panel will go into a fire trouble condition. It will also transmit the fire trouble to the CS, if programmed to do so.
- ✓ Zones 1-9 are entered as 01 - 09.

Loop Response (750mS required for UL installations)

Loop response is the amount of time in milliseconds (mS) that a normally-closed circuit must remain open, or a normally-open circuit must remain closed, to trigger an alarm. The slower the loop response, the more immune the system will be to intermittents



("swingers"). Loop response times for Zones 1 through 8 are programmed into the control panel; those for Zones 9 through 96 loop responses are selected at the respective keypad configuration mode or expansion module jumper. (Refer to keypad instructions and EZM Installation Instructions.)

Selectable loop-response times for Zones 1–8 are:

750mS (.75 sec.): The slowest loop-response time, recommended for use with magnetic contacts, window foil, etc. Unless programmed otherwise, loop-response time will be 750mS for all zones.

50mS (.05 sec.): Used for momentary Panic Buttons and area-protection devices, such as photoelectric eyes, passive infrared sensors, floor mats, etc.

10mS (.01 sec.): An extremely fast loop response used primarily for window bugs.

Low Battery (Required for UL Mercantile installations)

A low-battery system trouble will annunciate at the keypad when the battery terminal voltage drops below normal. This condition may signal a local sounding device, report to a central station (program Panel Low Bat Report Code), or both. If a battery is installed and low terminal voltage is detected, a restore will not occur until the battery is recharged to its specified level and passes a dynamic test. The dynamic test may be initiated manually by pressing the **RESET** button, or it will be initiated automatically, every four hours, by the panel.

In wireless installations, when displaying RF transmitter status, a "LoBatt" indication denotes a low-battery condition at the transmitter.

Master Security Code **Dealer Security Code** **Download Security Code**

The factory-programmed Master Security Code (printed on the label affixed to the micro can) is unique and cannot be changed. Use this code to enter the Dealer Program Mode to program (or change) the Dealer Security Code. If a Dealer Security Code is programmed, both the Dealer Security Code and the Master Security Code will work. However, should system RAM fail, only the Master Security Code will work.

The Dealer Security Code is needed to enter the Dealer Program Mode, thus allowing the dealer to program codes, zone features, reporting features and zone descriptions (see Programming Manual WI777). This code may be changed as required.

Important! The label containing the Master Security Code should be removed. Record the code in a secure place for reference as programming changes cannot be made without it (or the Dealer Security Code).

To change the Dealer Security Code, access the Direct Address Program Mode. Advance to the "PROG" screen, then change the 6-digit code as required.

The Download Security Code is the six-digit code required to establish connection to the PCD3000 Software.

Memory Failure

A User or Dealer Memory error will cause the sounder to pulse, the "SYS/TRBL" reminder to flash, and the display to read "E19-00 USER MEM ERROR" or "E20-00 DEALER MEM ERROR". Press the **RESET** button to silence the sounder ("SYSTEM READY" will display, along with the "SYS/TRBL" reminder). Activate RESET SYSTEM TROUBLE to manually reset the system trouble. A Memory Failure can be programmed to activate an alarm output and/or report using its associated system Report Code.

Modem Ite CS Format

The GEM-P9600 control supports Radionics Modem Ite central station reporting format.

Never Arm (Do not use for primary Burglary protection)

A zone programmed as Never Arm cannot go into alarm. If tripped, it will display at the keypad when the DISPLAY STATUS function is selected. A chime will sound at the keypad while armed or disarmed, if Chime is also programmed for that zone and enabled. This feature is suggested for use as a garage-door or driveway monitor, or similar application.

No EOL Resistor

Program for any zone not wired with a 2200 Ohm end-of-line resistor (Napco Part No. EOL2.2K). This will disable any zone-short indication (if programmed, Day Zone Short is disabled). If not programmed, an end-of-line resistor must be installed. Note: This selection is automatically disabled for zones selected as Fire.

Number of Rings Before Pickup See Callback-Method Download

One-Button Arming See Easy Arming

Opening Report

Opening Report Only After Alarm Report (Do not program for UL installations)

Opening and closing reports are generally used in commercial installations. On disarming, the communicator can send an Opening Code for Users 1–96 (Opening Report), or it may transmit only when the control panel is disarmed after an alarm has been reported (Opening Report Only After Alarm Report). (Note: Key Fobs 1–8 report as Users 81–96.) Subscriber Identification Numbers and Opening Codes must be entered for either opening report.

Program Opening Report Only After Alarm Report to report only when disarming after an alarm report. This feature may be used by the central station to verify that the subscriber has responded and disarmed the panel. If Opening Report Only After Alarm Report is selected, also select Opening Report for each user.









Opening/Closing Reporting for Key-fob Users

Key-Fob users can now report openings and closings.

- GEM-P9600: Key Fobs 1-16 report as Users 81-96.

Panic Zone**Keypad Aux Panic****Keypad (Police) Panic****Keypad Fire Panic** See Fire**Remote Panic**

The Panic Zone is always a 24-Hour Zone. Each keypad is individually selectable for keypad panics (see Keypad Features). If Keypad Panic is programmed for a keypad, police panic is activated by simultaneously pressing the  and  buttons. If Keypad Aux. is programmed, pressing  and  buttons simultaneously will trip an auxiliary emergency alarm. If Keypad Fire is programmed, pressing  and  buttons at the same time will activate fire panic.

A remote panic button may be connected to a GEM-RP2ASe2 Keypad. Splice the two white wires from the keypad to a normally-open momentary-contact pushbutton. Additional panic buttons may be wired in parallel with the first. If remote panic will not be used, insulate both white wires, as a short across them will cause a panic alarm. (In UL installations, remote-panic buttons must be located within 3 feet of the keypad, with no intervening walls or barriers.)

Power-Up Delay

If programmed, power-up will be delayed for 5 minutes to allow devices such as PIRs time to stabilize (warm up). This will prevent false alarms when ac power is restored after a long power outage and the backup battery is discharged.

Pre-Alarm Warning (Not for UL applications)

Programmable by zone, this feature will cause an alarm to sound only at the keypad for the duration of the programmed abort delay (see Abort Delay; Time Selection). After the delay has elapsed, the alarm output will activate and a report will be sent. **Note:** If no Abort Delay time is programmed, Pre-Alarm Warning time will be 10 seconds.

Pre-Dial Delay

A Pre-Dial Delay may be used whenever a delay is required before dialing. It may be required when programming Dial-Tone Detection, which causes the communicator to wait before it attempts to detect a dial tone (see Dial-Tone Detection). Certain telephone exchanges send a nonstandard dial tone that the communicator may not be able to detect. With these nonstandard exchanges, it is possible to program Pre-Dial Delay rather than Dial-Tone Detection. This will cause the communicator to wait for a predetermined period of time before dialing rather than look for a nonstandard dial tone.

Contact the telephone-equipment supplier to find out how long a delay is required before dialing. Select Pre-Dial Delay by programming one "D" for each 4-second delay required immediately before the telephone number. **Note:** In UL installations, do not program more than one "D" before the telephone number.

See Backup Report on Telco 2; Report Telco 3 (Double or Split Reporting). Also see Access Number for Outside Line; Telephone Numbers.

Priority Area Arming

Prevents area arming if the alternate Priority Area has not yet been armed.



Priority Zone (Required for all zones in UL installations.)

A zone that will prevent arming if in trouble. If an attempt is made to arm, the sounder will come on and "ZONES NOT NORMAL/CAN'T ARM" will be displayed for 4 seconds. The keypad may be reset by simply pressing the  button. The problem on a Priority Zone must be corrected before the panel can be armed.

Any zone may be selected as a Priority Zone. A zone in trouble that is neither a Priority Zone nor an Auto-Bypass Zone will cause an alarm on arming.

Priority Zone with Bypass

A Priority Zone that will permit arming if the priority condition is bypassed. If the system is so programmed, the zone will auto-bypass and (optional) the condition will be reported to a central station.

As above, if an attempt is made to arm, the sounder will come on and "ZONES NOT NORMAL/CAN'T ARM" will be displayed. To reset the keypad, press the  button; the display will read "ZONE FAULTS". To arm the panel, press the  button, then enter the User Code.

Any zone not selected as a Priority Zone may be programmed as a Priority Zone with Bypass.

Pulse Burglary Output See Alarm Outputs

Receiver Format

The communicator can be programmed to transmit to any standard central-station receiver. A receiver format must be entered for each telephone number used, but a different format may be assigned to each.

Refer to Backup Report on Telco 2 and Report Telco 3 to determine whether or not Telephones 2 and/or 3 will be programmed. Call the central station for each telephone number used to confirm the type of receiver in use. Select the receiver format entry for each telephone number from the following table.

ENTRY	RECEIVER FORMAT	DATA FREQ. (Hz)	DUTY CYCLE (ON/OFF)	INTERDIGIT TIME
(blank)	Ademco, Silent Knight Slow	1900	60/40mS	600mS
1	Sescoa, Vertex, DCI, Franklin Fast	1800	30/20	800
2	Radionics Fast	1850	13/12	400
3	Silent Knight Fast	1900	40/30	560
4	Radionics, DCI, Franklin Slow	1800	60/40	600
5	Universal Hi-Speed	1850	30/20	350
8	Radionics BFSK	Modem Formats		
9	4/3/1*			
A	Radionics Modem 2*			
B	SIA*			
C	Point ID*			
D	Express (Touch-tone 4/2 Format)			
0	Radionics Modem IIe			

*These formats do not use programmable codes, but Event ID Codes to identify the type of zone as follows:

- 1 – Fire
- 2 – Panic
- 3 – Burglary
- 4 – Holdup
- 7 – Gas Alarm
- 8 – Heat Alarm
- A – Auxiliary Alarm (keypad displays “0”)
- B – 24-Hour Auxiliary Alarm

Relay Control (External Relays)

In addition to the three relays provided on the motherboard, up to 24 external relays (8 per RB3008 Relay Module) or X-10 devices (24 per GEM-X10 module) may be controlled from the keypad, by event or by schedule through the use of PCD3000 downloading software. Program these outputs to activate by event on PCD3000 External Relay Control screen, or by schedule on the Event Scheduler screen.

Relay Follows Zone

External Relays can be programmed to follow an open or shorted zone. On the PCD3000 External Relay Control screen, program the External Relay to “follow” an open zone, or to “follow” a shorted zone.

Relay Outputs See Alarm Outputs

Relay / X-10 Mapping

It is possible to have a relay or X-10 device activate for multiple events, with a maximum of 24 events. This allows the relay or X-10 device to be activated by multiple events or conditions. This is programmed by assigning or mapping events to relay numbers. PCD3000 must be used to program Relay/X-10 mapping. Referring to the PCD3000 External Relay Control screen, the “Relay / Entry#” column typically indicates the number of the relay which will accept the commands on that line. However, the “Map” column, which is used to transfer the function defined on that line to a device on another line.

Remote Panic See Panic Zone

Report Telco 1

Report Telco 3 (Double or Split Reporting)

Alarms, alarm restores, troubles and trouble restores may be selected individually for each zone. Violation of a zone selected to report will communicate the code(s) selected for that zone to the central station.

Normally, Report Telco 1 is used to report to the central station. Report Telco 3 is used when certain zones will report to a

GLOSSARY

different receiver (split reporting); Report Telco 1 and Report Telco 3 are both used on the same zone to report to two receivers successively (Double Reporting). (Double Reporting requires a successful report to Telco 1 before reporting to Telco 3.) Also see Backup Report on Telco 2.

Reset Day Zone with Arm/Disarm Only See Day Zone

Reset Relay See Alarm Outputs

Resound on Wireless Smoke Low Battery

If a wireless smoke detector low battery is detected, it will re-sound the trouble at the keypad every 4 hours when disarmed and every 12 hours when armed, until the condition is corrected.

RF Jam Reporting

RF Receiver Jam will report as RF Receiver Trouble.

Silence All Outputs During Audio Session with Lug E19

Whenever an active low is applied to control-panel Lug E19 (Listen-In), all output relays will turn off. Connect Veri-Phone Terminal 16 (INHO) to Lug E19.

Selective Bypass

Disable Code Required for Easy Bypass (Not for UL installations.)

Any or all zones (1–96) programmed for Selective Bypass may be removed from the system, but each must be removed separately. Refer to BYPASSING ZONES in Section 3 for operation.

Security Bypass, recommended for commercial applications, requires entry of a valid user code.

Easy Bypass, recommended for residential applications, is selected by programming Disable Code Entry for Easy Bypass; this will permit bypassing/unbypassing zones without the need of entering a code (see Easy Bypass in Section 3). Do not program this feature in high-security applications.

When one or more zones is bypassed, the "BYPASSED" reminder on the GEM-RP1CAe2 keypad will display.

Sensor Watch

Program for any zone containing a PIR or dual-technology sensor, floor mats, door contacts, or other device where some activity is expected. This feature supervises the sensor by verifying that the zone activates before the PIR timer runs out. If no trip is detected within the programmed Sensor-Watch time, a system trouble will result and "E22-NN PIR SENSOR TRBL" will be displayed at the keypad, where NN are the zone number(s). Select the RESET SENSOR MSG function to reset this system trouble.

Program the Sensor-Watch PIR timer in Location 4088. Select a value in accordance with the anticipated activity within the coverage area while disarmed. In calculating the Sensor-Watch time, note that only the disarmed hours (the time between armed periods) are added. In moderate traffic areas, a Sensor-Watch time of perhaps 1 hour may be appropriate, whereas in remote areas, a time of 8 hours or more may be in order. Supervision time should be calculated for the supervised zone with the least amount of traffic. Up to 255 hours may be programmed (see Time Selection).

Silence All Outputs During Audio Session See Veri-Phone

Single-Digit Format See Data Format

Smoke Detectors

Connect smoke detectors as shown in the following diagrams. The normally-closed contacts of the Reset Relay are used to reset the smoke detectors.

Two-Wire Smoke Detectors. Two-wire smoke detectors may be connected to zones 1-8 on the control panel. Up to 10 compatible 2-wire smoke detectors may be wired to each zone. In Residential applications, program Pulse Burg Output. Program Disable Fire Reset in the applicable area(s).

Zones 7 and 8 have been designed so they can be easily configured as 2-wire smoke detector zones by means of jumpers (JP7) located above Terminal 21.

1. Program Zones for 2-Wire Smoke Detectors and Fire.
2. If Zone 7 is selected as a 2-Wire Fire Zone, move the left jumper on JP7 from the top two pins (BURG) to the bottom two pins (2WF).
3. Similarly, if Zone 8 is selected as a 2-Wire Fire Zone, move the right jumper on JP7 from the top two pins (BURG) to the bottom two pins (2WF).
4. Connect 2-wire smoke detectors to Zones 7 and/or 8 as shown.

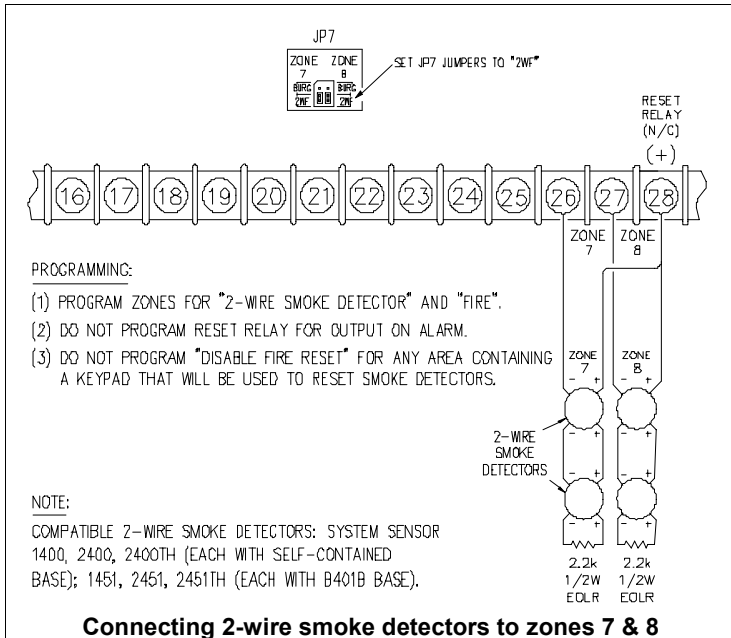

Where more than two 2-wire smoke detector zones are required, select any of Zones 1-6 for 2-wire fire as follows:

1. Program the selected zone(s) (1-6) for 2-Wire Smoke Detectors and Fire.
2. Cut out the 2700W resistor (color code: red/violet/red) associated with the selected zone(s). See table below.

ZONE	RESISTOR	LOCATION ON BOARD
1	R1	ABOVE TERMINAL 18
2	R2	ABOVE TERMINAL 18/19
3	R3	ABOVE TERMINAL 19
4	R4	ABOVE TERMINAL 20
5	R5	ABOVE TERMINAL 22
6	R6	ABOVE TERMINAL 23

3. Install a 130W resistor (Napco Part No. EOL130; color code: brown/orange/ brown), 3 watts, across the two terminals of each selected zone.
4. Wire the positive (+) terminal of the smoke detector to Terminal 28. Wire the negative (-) terminal of the smoke detector to the positive terminal (+) of the zone.

(SEE PAGE 17 FOR ADDITIONAL WIRING INFORMATION)

Four-Wire Smoke Detectors. If installing 4-wire smokes, subtract smoke-detector alarm current from available standby current. See COMPATIBLE UL-LISTED DEVICES.

Wire 4-wire smokes as shown in the following wiring diagram. Program each zone for Fire. Also program zones for Pulse Burglary Output, and Disable Fire Reset in the applicable area(s) (System Options). If they are of the self-resetting type, 4-wire smokes may be powered from Terminals 13 and 14 (AUX. PWR.) instead of Terminal 28 and 29, thus freeing the Reset Relay for other uses.

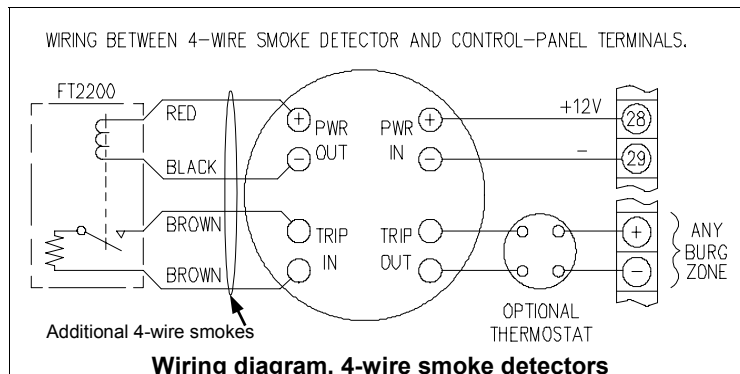

Split Reporting See Report Telco 3

Start Exit Delay After Ringback

GLOSSARY

When a closing report is successfully received, the central station will acknowledge by returning a kissoff signal. When the kissoff is received by the communicator, a 2-second ringback tone will sound at the keypad. Start Exit Delay After Ringback will cause the exit delay to start after the ringback sounds.

If this option is chosen and no ringback sounds shortly after the control panel is armed, exit delay will not start and opening the exit/entry door will cause an instant alarm. To manually start the exit delay, select the START EXIT TIME function, then press the  button to execute.

Note: (1) If this feature is selected, Exit/Entry Follower Zones will not arm until either a ringback sounds or the START EXIT TIME function is used. (2) If communicator, telephone lines or central-station receiver is out of service, the system will be armed without communication capability.

Status Report See Closing Report

Subscriber Identification Numbers

If reporting openings and/or closings, program Subscriber Opening/Closing Identification Numbers for each area for each telephone number used. If reporting events, program Subscriber ID Numbers for each area for each telephone number used. Subscriber ID numbers must be programmed for each area and telephone number, even if all are the same. Start with the left-most location.

Sum Check See Data Format

Supervised Bell Output

When the option Supervised Bell Output is enabled, a 2.2K ohm resistor must be installed across the bell or sounding device terminals. In the event that the Burg Output is cut, or the circuit is opened, an E51-00 FIRE BELL TRBL trouble condition will occur. Note: Due to the fact that there is a constant loop current flowing through the Burg Output circuit for supervision, some sirens or siren drivers may emit a low volume hum or buzz if the 2.2K EOL resistor is not installed. If Supervised Bell Output is not required, this can be eliminated by cutting resistor R207 which is located just to the right of the Burg Output relay adjacent to the Burg Output terminal.

Suppress "BYPASSED" Reminder When Armed (Must be enabled in all UL systems)

Program to inhibit the LCD "BYPASSED" display while armed.

Swinger Shutdown (Do not program for UL Installations.)

Program for zones with Auto-Reset to only reset twice (3 alarms) until rearmed to prevent "swingers" (intermittents) from causing repeated false alarms. See Auto-Reset. The Swinger-Shutdown feature is programmable by zone, but is not applicable to Ambush.

System Troubles (Global and Area)

System troubles may be programmed to report to any telephone number and/or activate any output. Also program Subscriber ID Numbers, Telephone Numbers, and Report Codes for each system trouble.

Note: RF TROUBLE will report for RF Low Battery, RF Supervisory Failure or GEM-DT Self-Test Failure.

System Trouble Audible Automatic Timeout

Inhibit System Trouble Audible

In the event of a System Trouble while the system is disarmed, the keypad will scroll the trouble description in the display and activate the sounder until [RESET] is pressed. If [RESET] has not been pressed within 10 minutes of the trouble, the sounder will automatically turn off in 10 minutes.

To disable System Trouble Audible Automatic Timeout, enable *Disable System Trouble Audible Timeout* in the PCD3000 Keypad Features screen. NOTE: If the system were Armed when the trouble occurred, the keypad would display the SYS TBL icon, but NOT activate the sounder.

For installations where an audible on system trouble is not desired at all, the option, *Inhibit System Trouble Audible* can be enabled. Regardless of the system status, Armed or Disarmed, there will be no keypad sounder at all in the event of a system trouble. However, the trouble will still scroll in the keypad display until [RESET] is pressed and the SYS TBL icon will display until the trouble is restored. (Do Not program in UL Installations)

- To disable System Trouble Audible, enable the option *disable System Trouble Audible* in the PCD3000 Keypad Features screen.

Tamper

EZM Tamper

Keypad Tamper

RF Tamper

Removing the cover of an expansion zone module will cause the sounder to pulse and the "SYS/TRBL" reminder to flash. The keypad will display "E13-NN BURG EZM TAMPER", where "NN" denotes the module number. Press the  button to silence the sounder ("SYSTEM READY" will display). Correct the problem, then select RESET SYSTEM TBL to manually reset the system trouble display.

Removing a keypad from the wall causes a similar system trouble indication. The keypad will display "E11-NN BURG KPD TAMPER", where "NN" denotes the keypad number. Press the  button to silence the sounder ("SYSTEM READY" will display). To manually reset the system trouble, correct the problem then select RESET SYSTEM TBL.

Note: If either of the tamper conditions is not corrected within 5 minutes, the system trouble will again display at the keypad.

A Tamper condition can be programmed to activate the burglary output and/or report using its associated system Report Code. In wireless installations, when displaying RF transmitter status, a "Tamper" indication denotes that the transmitter case is open.

Telco Answering Service Override

If using the PCD3000 PC downloader Software, the Telco Answering Service can now be disabled. Call the panel, hang up after one ring by pressing the F10 key. The PCD3000 will automatically call the panel back and the panel will answer in one ring.

Telco Fail See Enable Line-Fault Test

TELCO FAIL ONLY WHEN ARMED

The Telco Line Cut Monitor will only be active when the system is armed.

Telco Line Test Delay See Enable Line-Fault Test; Time Selection

Telemetry Trouble

If any device connected to the on-board Serial Port (such as a Home Automation system or AES Radio) fails to respond to a poll by the control panel, a Telemetry Trouble system trouble will result. On the PCD3000 System Features screen, enable Telemetry Trouble: = XT to report on alarm or activate and output. On the PCD3000 System Reporting Codes screen, program a reporting code for Telemetry Trouble.

<i>Keypad readout will be:</i>	ES8-00 SERVICE TELEMETRY TRBL	
<i>The event Log will read:</i>	TROUBLE: TELEMETRY TROUBLE RESTORE: TELEMETRY	
<i>Keypad programming</i>	Address Location 1099 = [•][]	4 - Telemetry Trouble
<i>Telemetry Trouble:</i>		8 - Telemetry Fail

Telemetry Failure

If the device connected to the on-board Serial Port (such as a Home Automation system or AES Radio) is not able to carry out its intended function, it can send a signal to the control panel, and a Telemetry Trouble system trouble will result. On the PCD3000 System Features screen, enable Telemetry Failure: = XF to report on alarm or activate and output. On the PCD3000 System Reporting Codes screen, program a reporting code for Telemetry Failure.

<i>Keypad readout will be:</i>	ES9-00 SERVICE TELEMETRY COMM	
<i>The event Log will read:</i>	TROUBLE: TELEMETRY FAIL	
<i>Trouble Restore:</i>	TELEMETRY FAIL	
<i>Keypad programming</i>	Address Location 1100 = [•][]	4 - Telemetry Trouble
<i>Telemetry Failure</i>		8 - Telemetry Fail

Telephone Numbers

Dialing Prefix

To report to a central station, Telephone Number 1 must be programmed. Telephone Number 2 is programmed for Backup Reporting; Telephone Number 3 is programmed for Double or Split Reporting.

Private telephone systems may require a Dial-Tone Detection "E" or Pre-Dial Delay "D", followed by an access number to obtain an outside line. (See Access Number for Outside Line.)

It should be noted here that the telephone number need not actually start in the first location shown, and may not end in the last. Extra locations have been provided to allow for one or more prefix digits: a Pre-Dial Delay "D" or a Dial-Tone Detection "E". What is important is that the telephone number, with its associated Pre-Dial Delay, Access Number, and Dial-Tone Detection, be wholly contained within that group of locations, and that they be in their proper sequence.

If needed, a Dialing Prefix of up to 20 digits may be programmed. This prefix will be dialed immediately before the programmed Central Station telephone numbers.

Test Timer

Cancel Next Test Timer Report on Any Report

The test timer schedule is programmed using NAPCO's PCD3000 Quickloader Software. If Test Timer is programmed, an automatic test report will be transmitted to the central station on the scheduled day(s) at the scheduled time. (UL installations require a report at least every 24 hours.) To report test timer, select Report Test Timer and program a report code. Program the Test Timer event schedule and reporting time.

If Cancel Next Test Timer Report on Any Report is programmed, any report will cause the next test-timer transmission to be aborted, however subsequent test-timer transmissions will report as scheduled. Do not program this feature in UL installations.

GLOSSARY

Timeout

Specifies the length of time that an alarm, alert, or delay will remain active. Auxiliary Output Access Control Time, Abort-Delay Time, and Chime Time must be programmed, or the feature will not activate. See Time Selection.

Time Selection

The following times are programmable:

TIME ⁽¹⁾	UNITS	MAX. PROG. TIME
RESET OUTPUT	MIN.	UNTIMED ⁽²⁾
AUXILIARY OUTPUT	MIN.	UNTIMED ⁽²⁾
AUXILIARY OUTPUT ACCESS CONTROL TIME	SEC.	4 MIN, 15 SEC (255 SEC)
BURGLARY OUTPUT	MIN.	UNTIMED ⁽¹⁾⁽²⁾
PULSE-BURG OUTPUT	MIN.	UNTIMED ⁽¹⁾⁽²⁾
FIRE OUTPUT	MIN.	UNTIMED ⁽²⁾
ABORT DELAY	SEC.	4 MIN, 15 SEC (255 SEC) ⁽³⁾
CHIME TIME	¼ SEC.	63.25 SEC (255 QTR-SEC) ⁽³⁾
AC-FAIL REPORT DELAY	10 MIN.	42 HR, 30 MIN (2550 MIN)
EXIT DELAY	SEC.	4 MIN, 15 SEC (255 SEC) ⁽⁴⁾
ENTRY DELAY 1	SEC.	4 MIN, 15 SEC (255 SEC) ⁽⁴⁾
ENTRY DELAY 2	SEC.	4 MIN, 15 SEC (255 SEC) ⁽⁴⁾
TELCO LINE-TEST DLY	SEC.	4 MIN, 15 SEC (255 SEC) ⁽⁵⁾
AUTO ARM REARM DLY	MIN.	4 HR, 15 MIN (255 MIN)
SENSOR-WATCH TIME	DISARMED HOURS	255 HOURS ⁽⁶⁾

NOTES: ⁽¹⁾ The output used for Burglary must be at least 4 minutes in Residential UL installations, 15 minutes in Commercial UL installations. ⁽²⁾ If both locations are left blank, this feature will remain active until the system is disarmed. When both locations are programmed "F", maximum time will be 4 hours, 15 minutes (255 minutes). ⁽³⁾ If both locations are left blank, this feature will not activate (timeout = 0). ⁽⁴⁾ In UL installations: Maximum Exit Delay = 60 sec; Maximum Entry Delay = 45 sec. ⁽⁵⁾ If programming locations are left blank, delay will default to 10 sec. ⁽⁶⁾ Time in units of disarmed hours (accumulated between armed periods).

Any timeout up to those shown in the foregoing table may be programmed. Note that each of the above times is programmed in two locations. The first location has an assigned time factor of 16, the second a time factor of 1.

1st BOX	2nd BOX
tx16	tx1

Time t:	0	1	2	3	4	5	6	7	8	9	10	11	12	13	14	15
Entry:	*	1	2	3	4	5	6	7	8	9	0	B	C	D	E	F

*Blank.

Note: If both programming locations are left blank, refer to the notes in the Time Selection table for feature timeout.

To select a time up to 15 seconds, 15 minutes, 15 hours, or 15 days, program the respective entry into the second box only; do not program the first box. To select a time greater than 15 seconds, 15 minutes, 15 hours or 15 days, program both boxes as follows:

1. For the feature selected, choose an appropriate time in units shown (all seconds, minutes, hours, or days — not minutes and seconds, etc.).
2. Divide the time chosen by 16. Enter the quotient in the 1st BOX and the remainder in the 2nd BOX.
3. Check entries by adding the contents of the 2nd BOX to 16 times the contents of the 1st BOX. (Remember that a "zero" entry represents 10.)

Example. Program Entry Delay 1 for 1 minutes.

1. Entry Delay 1 is in units of seconds, thus delay time is 90 seconds.
2. Divide by 16: 90/16 = 5 (quotient) + 10 (remainder).
3. Enter the quotient in the 1st BOX and the remainder in the 2nd BOX
4. Check entries (remember, a "0" entry = 10): (16x5) + 10 = 90

1st BOX	2nd BOX
5	0
quotient	remainder ("0" for 10)

TouchTone Dialing Only

TouchTone Dialing with Rotary Backup

Select TouchTone Dialing Only if the subscriber has TouchTone service. TouchTone dialing is faster than rotary dialing, but not always as reliable.

For the communicator to use TouchTone on all dial attempts, program TouchTone Dialing Only. To use TouchTone on the first attempt with subsequent Rotary dial, program TouchTone Dialing with Rotary Backup. TouchTone Dialing Only will override TouchTone Dialing with Rotary Backup if both are selected. Note that if Backup Reporting is also selected, the communicator will alternate between TouchTone and rotary dial to reach Telephone 1, then Telephone 2. See Backup Report on Telco 2.

Transmit "402" Closing Code

Program to send a "402" closing code (for Ademco Point ID modem format) in place of a "401" code.

Trouble

An abnormal zone condition (a break in a normally-closed loop; a short on a normally-open loop; or either on an end-of-line-resistor supervised loop) when disarmed.

Trouble on a Burglary Zone is automatically displayed at the keypad unless Disable Auto Status is programmed. If a Burglary Zone is in trouble, it will go into alarm about 10 seconds after arming. However, if Auto Bypass is programmed, the keypad will beep upon arming (does not apply to selective- or group-bypassed zones).

Trouble (open and/or short circuit) on a Day Zone is indicated by a pulsing sounder; display the Day Zone(s) in trouble on the LCD. Keypad indications are reset by the **RESET** button unless Reset Day Zone With Arm/Disarm is selected.

Trouble on a Fire Zone will be indicated by the "FIRE/TRBL" reminder and the sounder. An open circuit (trouble) will cause a flashing "FIRE" display and a pulsing sounder after a 15-second delay. (A short circuit will cause an alarm condition: steady-on "FIRE" display and pulsing sounder.) The **RESET** button will silence the sounder. Clear the trouble, then press the **RESET** button once again. The keypad will reset after a brief delay.

Trouble on Open**Trouble on Short****Trouble on Night Open** (Not for UL installations)

Trouble on Open will identify an open circuit on a loop as a trouble. Trouble on Short will identify a short circuit as a trouble. Trouble on Night Open, which will identify an open circuit on a normally-closed zone while armed as a trouble condition (not an alarm), is intended for use with a Napco Monitor-Series dual-technology sensor. While there will be no indication at the keypad, any of these trouble conditions can be reported if Report Trouble is programmed as well. See Sensor Watch.

Trouble/Trouble Restore Telco 1/Telco 3 See Report Telco 1/Telco 3

Trouble/Trouble Restore Telco 2 See Backup Report on Telco 2

Two-Digit Format See Data Format

Two-Wire Smoke Detectors See Smoke Detectors

User Codes/Authority Levels/Access Bytes**User Closing and Opening Reports by Telephone Numbers****Enable User Code by Area**

Up to 96 six-digit User Codes are programmable, each with its dedicated Authority Level and Access Byte. (The Authority Level comprises an Option Code.) Refer to Programming Manual WI777 for descriptions of levels and options.

If reporting to a central station, program User Closing and Opening Reports by Telephone Numbers. In multiple-area systems, program Enable User Code by Area.

Unsupervised Transmitters

(Programmable with PCD-3000 Software Only) Transmitters can now be unsupervised by programming a "9" in place of point number "1". **NOTE:** All points of that transmitter will be unsupervised.

Veri-Phone™**Silence All Outputs During Audio Session****Veri-Phone Zones Priority Over Alarms****Veri-Phone Zones Trip Auxiliary Relay**

If Silence All Outputs During Audio Session is selected, all output relays will turn off whenever an active low is applied to control-panel Lug E19 (Listen In). Connect Veri-Phone Terminal 16 (INHO) to Lug E19. **Note:** Do not program Keypad Sounder on Alarm for Listen-In Zones.

If Veri-Phone Zones Priority Over Alarms is programmed and an active low is applied to the panel's Listen-In Lug (E19), any subsequent alarm reports (except fire alarms) generated during an audio session will be delayed until the end of the session. (Whenever a listen-in session is in progress, the Veri-Phone will output an active low at its INHO Terminal (16) and Lug E1.)

Program Veri-Phone Zones Trip Auxiliary Relay to have selectable Listen-In Zones. Connect Veri-Phone Terminal 14 (TRIGH) to control-panel Terminal 8 (AUX. N/O). Program the zone or event for Auxiliary Relay. Do not use the Auxiliary Relay for any other purpose.

Veri-phone Trips Fire Output

To have selectable Listen-In Zones, use the Fire Output to trigger the Veri-Phone. Connect Veri-Phone Terminal 13 (TRIGL) to control panel Lug E9 (Fire Output). Program the zone or event for Fire Output; do not use the Fire Output for any other purpose. **NOTE:** Veri-phone trips Auxiliary Relay and Veri-phone trips Fire Output cannot be enabled together. The Auxiliary Relay can be used for Keyfob Chirp on arming and disarming.

Watch Mode (by Area) See Day Zone

Wireless Trouble Reporting by Zone All reports of Wireless trouble (Transmitter Low Battery, Transmitter Tamper, Transmitter



Supervisory Failure) to central station will identify identifying the zone of the transmitter.

Zone ANDing, Groups 1–2 (Not for UL installations)

Enable Local Alarm on First Zone “AND” Trip (Not for UL installations)

Up to eight groups of at least two zones each can be “AND”ed, wherein the system will go into alarm only if any two zones of the group are tripped within a prescribed time. This feature is designed to afford redundant protection for devices, such as glassbreak detectors, PIRs, etc., that may show a tendency to false under certain conditions. Program each group for any number of Zones 1–96. All zones in any group must be within the same area. Do not mix 24-Hour Zones and non-24-Hour Zones within the same group. Do not include a Panic Zone as part of any group.

Note: Any zone that is bypassed or goes into swinger shutdown will automatically disable Zone Anding for the entire group.

If Enable Local Alarm on First Zone “AND” Trip is programmed, a trip on any zone of the group will cause an alarm indication at the keypad only; there will be no communication to the central station.

Zone Area 1–Zone Area 8 See Areas

Zone Number on Pulse Alarm See Data Formats: Two-Digit Format

Zone Type See Data Formats: Modem Formats

2-Wire, 4-Wire Smoke Detectors See Smoke Detectors

4-Wire Bus Failure See Bus Failure

24-Hour Zone

A zone that provides protection at all times, whether or not the system is armed. If programmed for silent alarm (no Audible Outputs: Burg Output, Aux. Output, Fire Output or Keypad Sounder on Alarm programmed), the green LED will go out if the zone is tripped and it will display as a faulted Zone. The zone description will display on the LCD, therefore do not program a “panic” message for Panic Zones.

If an Audible output is programmed, the keypad will flash the red Armed LED and display “ALARM” followed by the zone description.

Note: Do not program a Day Zone as a 24-Hour Zone.

NOTES

STANDBY-BATTERY CALCULATION WORKSHEET

STANDBY-BATTERY CALCULATION WORKSHEET

Use the procedure given below to determine the required standby battery capacity in Ampere-Hours (AH). NOTE: It is not totally accurate to merely multiply the combined standby current (in amperes) by the standby time (in hours) to obtain the battery capacity (in ampere-hours), since other factors (control-panel charging capabilities, temperature, battery condition, etc.) affect battery operation. The following calculations will yield the theoretical minimum required capacity.

1. STANDBY CURRENT

DEVICE	QTY		STANDBY CURRENT (Amps)		
			EACH	=	TOTAL
GEM-P9600	1	X	0.120	=	
GM-EZM8		X	0.050	=	
GEM-RP1CAe2		X	0.100	=	
GEM-RP1CAe2 ⁽¹⁾		X	0.035	=	
GEM-RP2ASe2		X	0.065	=	
GEM-RP2ASe2 ⁽²⁾		X	0.020	=	
GEM-RP3DGTL		X	0.050	=	
RM3008 ⁽⁴⁾		X	0.040	=	
		X		=	
		X		=	
TOTAL STANDBY CURRENT			Amps (Box 1)		

- ⁽¹⁾ Backlighting disabled (cut Jumpers W1, W2 & W3).
- ⁽²⁾ Backlighting disabled (cut Jumpers A, B & C).
- ⁽³⁾ Add 0.010A for each energized relay.
- ⁽⁴⁾ Standby Time in Hours.

$$\text{Amps (Box 1)} \times \text{Amps (Standby Time)}^{(4)} = \text{AH (Box 2)}$$

2. ALARM CURRENT

DEVICE	QTY		ALARM CURRENT (Amps)		
			EACH	=	TOTAL
TOTAL STANDBY CURRENT (from Box 1, above)			Amps		
GEM-P9600 ⁽¹⁾		X	0.100	=	0.100
BELLS		X		=	
STROBES		X		=	
HORNS / STROBES		X		=	
		X		=	
		X		=	
TOTAL ALARM CURRENT			Amps		

$$\text{Amps} \times \text{Amps (Alarm Time)}^{(2)} = \text{AH (Box 3)}$$

- ⁽¹⁾ Alarm current drawn in alarm.
- ⁽²⁾ Alarm Time in Hours. Example: For a 15 minute alarm timeout, Alarm Time = 15/60 = 0.25.

$$\text{MINIMUM REQUIRED BATTERY CAPACITY} = \text{BOX 2} + \text{BOX 3} \rightarrow \text{AH}$$

WIRING LEGEND

Should removal of the circuit board be necessary, use this wiring legend to relocate wire leads to their proper terminals. Enter wire identification number or color code in WIRE NUMBER column and enter wire function in DESCRIPTION column (optional).

WIRING LEGEND

TERMINAL	WIRE NO.	DESCRIPTION
1		
2		
3		
4		
5		
6		
7		
8		
9		
10		
11		
12		
13		
14		
15		
16		
17		
18		
19		
20		
21		
22		
23		
24		
25		
26		
27		
28		
29		
30		
31		
32		
33		

KEYPAD PROGRAMMING MODES

- Note:**
- 1. Functions that are not active, not programmed and/or not applicable to user's authority level will be suppressed and will not display.
 - 2. Due to space constraints, GEM-RP2ASe2 messages are abbreviated.
 - 3. The function mode uses a real time, filtered display. Many functions may not be displayed until it's condition is satisfied. For example, "DISPLAY ZN FAULTS" will not display unless there is a faulted zone to display.

FUNCTION MODE

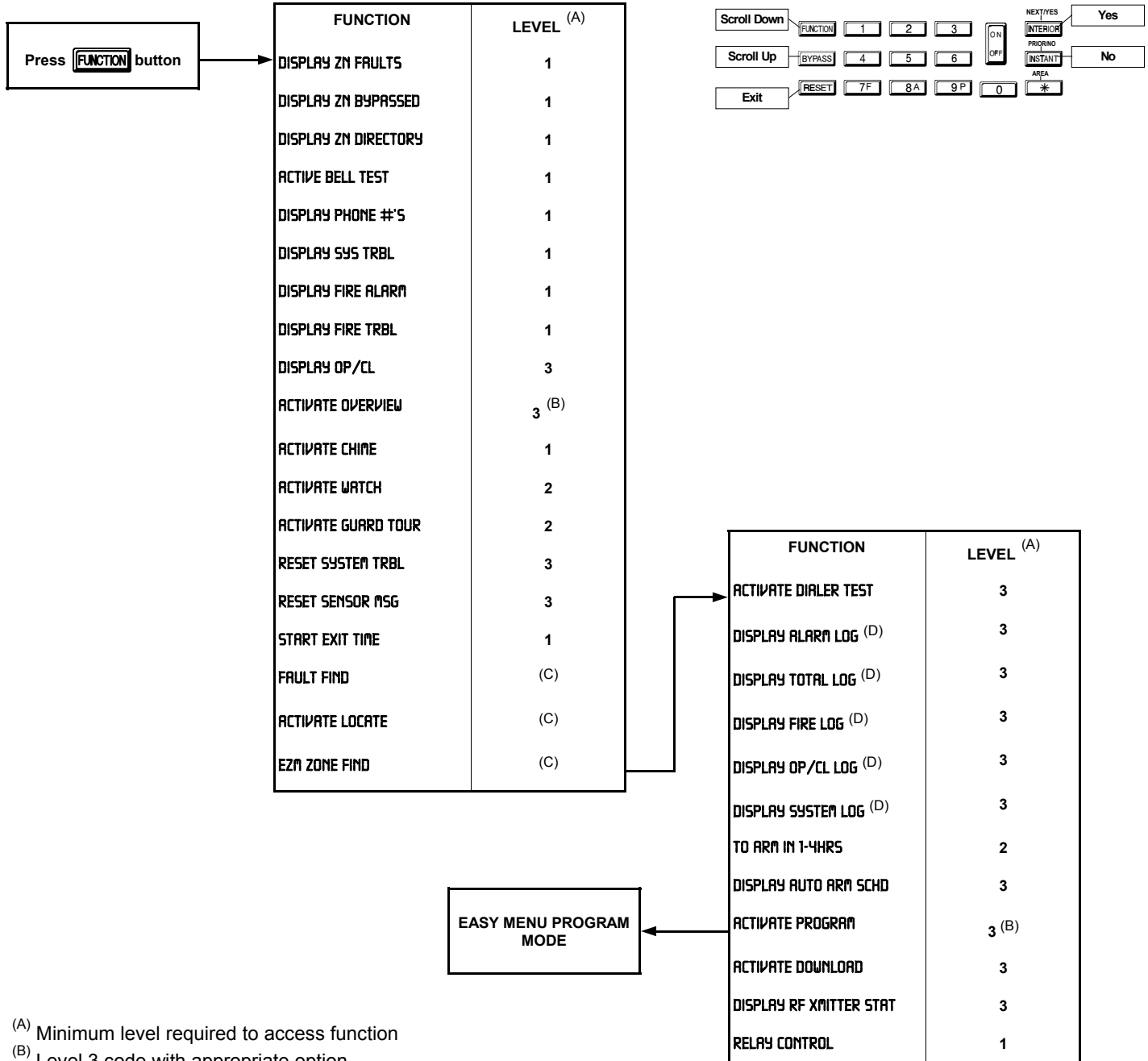

(A) Minimum level required to access function
 (B) Level 3 code with appropriate option
 (C) Requires dealer code
 (D) Not available in GEM-RP2ASe2 keypads
 (E) Initial Configuration only; suppressed thereafter

KEYPAD PROGRAMMING MODES

DEALER MODE

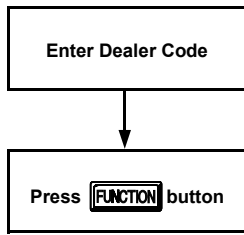

FUNCTION	LEVEL (A)
DISPLAY ZN FAULTS	1
DISPLAY ZN BYPASSED	1
DISPLAY ZN DIRECTORY	1
ACTIVE BELL TEST	1
DISPLAY PHONE #'S	1
DISPLAY SYS TRBL	1
DISPLAY FIRE ALARM	1
DISPLAY FIRE TRBL	1
DISPLAY OP/CL	3
ACTIVATE OVERVIEW	3 (B)
ACTIVATE CHIME	1
ACTIVATE WATCH	2
ACTIVATE GUARD TOUR	2
RESET SYSTEM TRBL	3
RESET SENSOR MSG	3
START EXIT TIME	1
FAULT FIND	(C)
ACTIVATE LOCATE	(C)
EZM ZONE FIND	(C)

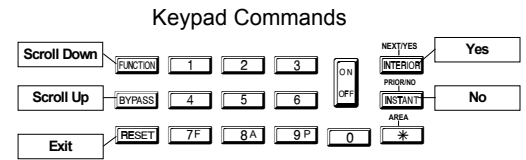

FUNCTION	LEVEL (A)
ACTIVATE DIALER TEST	3
DISPLAY ALARM LOG (D)	3
DISPLAY TOTAL LOG (D)	3
DISPLAY FIRE LOG (D)	3
DISPLAY OP/CL LOG (D)	3
DISPLAY SYSTEM LOG (D)	3
TO ARM IN 1-4HRS	2
DISPLAY AUTO ARM SCHED	3
ACTIVATE PROGRAM	3 (B)
ACTIVATE DOWNLOAD	3
DISPLAY RF XMITTER STAT	3
RELAY CONTROL	1

EASY MENU PROGRAM MODE

- (A) Minimum level required to access function
- (B) Level 3 code with appropriate option
- (C) Requires dealer code
- (D) Not available in GEM-RP2ASe2 keypads
- (E) Initial Configuration only; suppressed thereafter

KEYPAD PROGRAMMING MODES

EASY MENU MODE

FUNCTION

A1 #ZN-00 #KP-0; A2 #ZN-00 #KP-0 (E)

REPORT ALL ZONES TO CENTRAL? Y/N (E)

CENTRAL PHONE NO.

ACCOUNT # (____)

RCVR FORMAT

ENTER USER CODE

ENTER ZONE DESCRIPTIONS

RF XMITTER ID CODE # + POINTS

KEY FOB ID CODE # + OPTIONS

ENTER DATE (MM/DD/YY)

ENTER TIME (HH:MM/P)

Press **RESET** button
(at any time)

**DIRECT ADDRESS
PROGRAM MODE**

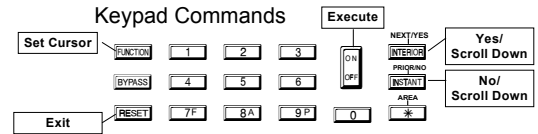

- (A) Minimum level required to access function
- (B) Level 3 code with appropriate option
- (C) Requires dealer code
- (D) Not available in GEM-RP2ASe2 keypads
- (E) Initial Configuration only; suppressed thereafter

KEYPAD PROGRAMMING MODES

USER MODE

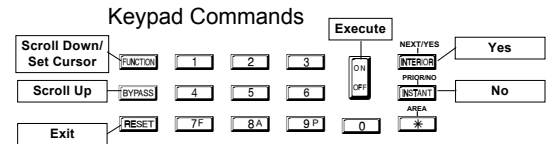
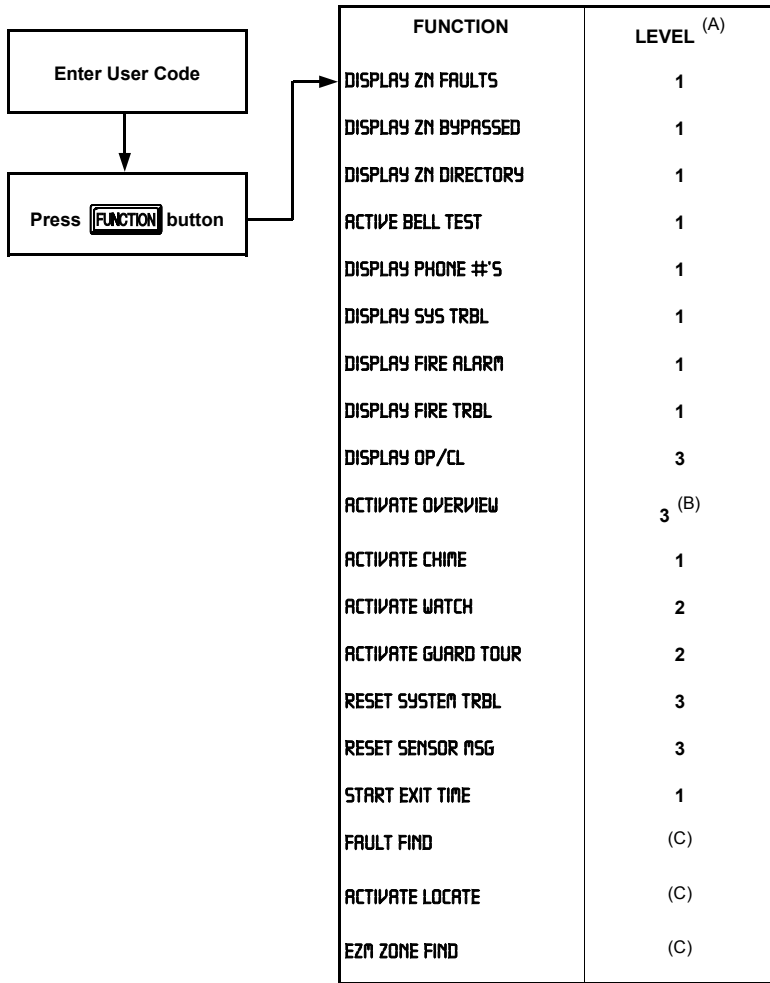

FUNCTION	LEVEL (A)
ACTIVATE DIALER TEST	3
DISPLAY ALARM LOG (D)	3
DISPLAY TOTAL LOG (D)	3
DISPLAY FIRE LOG (D)	3
DISPLAY OP/CL LOG (D)	3
DISPLAY SYSTEM LOG (D)	3
TO ARM IN 1-4HRS	2
DISPLAY AUTO ARM SCHED	3
ACTIVATE PROGRAM	3 (B)
ACTIVATE DOWNLOAD	3
DISPLAY RF XMITTER STAT	3
RELAY CONTROL	1

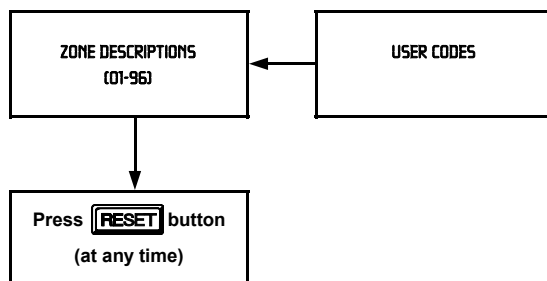

KEYPAD PROGRAMMING MODES

- (A) Minimum level required to access function
- (B) Level 3 code with appropriate option
- (C) Requires dealer code
- (D) Not available in GEM-RP2ASe2 keypads
- (E) Initial Configuration only; suppressed thereafter

KEYPAD CONFIGURATION MODE

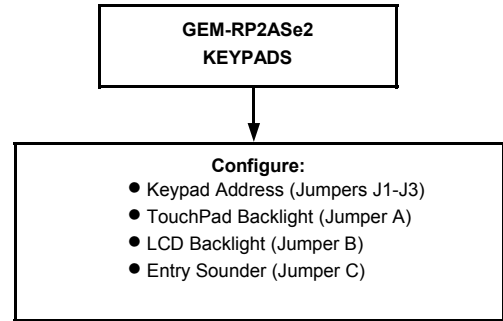
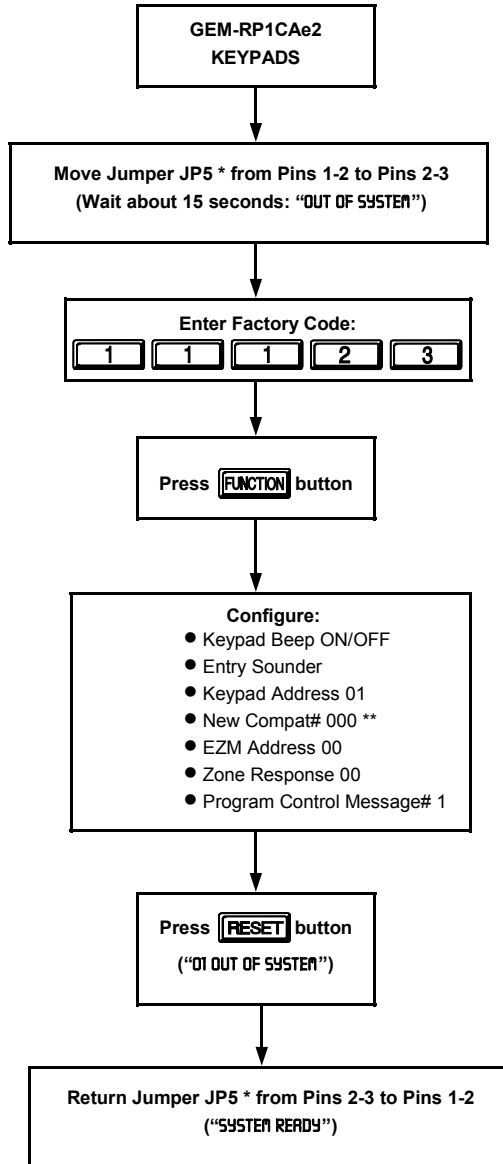

* JP5 is located at the top-right corner of the circuit board.

** If a Compatibility Number other than "0000" is programmed, "OLD COMPAT# XXXX" is displayed.

NOTES

GEM-P9600 WIRING DIAGRAM

GEM-P9600 WIRING DIAGRAM

NAPCO SECURITY SYSTEMS, INC
AMITYVILLE, NY. 11701



GEMINI GEM-P9600 WIRING DIAGRAM

(REFER TO OPERATION AND INSTALLATION INSTRUCTIONS WI742)

- 1.) END-OF-LINE RESISTORS, 2200 OHMS, RED, RED, 5% 1/2W, (EOL2,2K) ALSO INSTALLED IF ZONE NOT USED IN PANEL OR EZM, (INCLUDING FIRE AND PANIC). DO NOT INSTALL EOL RESISTOR ON FIRE ZONE IF USING FT2200 EOL RELAY.
- 2.) COMBINED STANDBY CURRENT=AUX POWER + REMOTE POWER + RESET RELAY + FIRE POWER. AN EQUAL AMOUNT FROM THE STANDBY CURRENT.
- 3.) BELL CURRENT MAY BE INCREASED BY SUBTRACTING IN THE BATTERY-ONLY MODE. (CONTACT CENTRAL STATION PRIOR TO TESTING)
- 4.) SYSTEM MUST BE TESTED AT LEAST ONCE A WEEK IN THE AC/BATTERY MODE AND IN THE BATTERY-ONLY MODE. (CONTACT CENTRAL STATION PRIOR TO TESTING)
- 5.) AC CONTACTS 2A/24VDC RESISTIVE (CUT JUMPER FOR DRY CONTACT)
- 6.) SEE WI742 FOR 2 WIRE SMOKE DETECTOR WIRING FOR ZONES 1-6.
- 7.) FOR U.L. RESIDENTIAL FIRE, CUT 'PS' JUMPER AND INSTALL SHUNT AC INTENDED TO BE MOUNTED ON THE WALL VERTICALLY
- 8.) UNIT INTENDED TO BE MOUNTED ON THE WALL VERTICALLY
- 9.) REFER TO WI742 FOR COMPATIBLE TWO WIRE SMOKE DETECTORS. DO NOT MIX DIFFERENT MODELS.
- 10.) RECOMMENDED BATTERIES: YUASA NP4-12 AND NP7-12. BATTERIES MUST BE REPLACED EVERY FIVE YEARS.
- 11.) THIS PANEL SHALL BE CHECKED BY A QUALIFIED TECHNICIAN AT LEAST ONCE EVERY THREE YEARS.
- 12.) AUX. POWER AND FIRE POWER VOLTAGE RATING 12.5VDC TO 11.7VDC.
- 13.) FOR SUPERVISION PROGRAM 'SUPERVISED BELL OUTPUT'
- 14.) THIS PANEL SUPPORTS ONLY ONE SMOKE DETECTOR IN ALARM FOR EACH ZONE.
- 15.) CUT TO DISABLE BELL SUPERVISION .DO NOT CUT IN U.L. INSTALLATIONS.

This equipment should be installed in accordance with Chapter 2 of the National Fire Alarm Code, ANSI/NFPA 72-1996 (National Fire Protection Association Batterymarch Park, Quincy, MA 02269), and local codes; information describing proper installation, operation, testing, maintenance, evacuation planning, and repair service is to be provided with this equipment. U.L. Listed Limited Energy Cable is required.

THIS UNIT INCLUDES AN ALARM VERIFICATION FEATURE THAT WILL RESULT IN A DELAY OF THE SYSTEM ALARM SIGNAL FROM THE INDICATED CIRCUITS. THE TOTAL DELAY (CONTROL UNIT PLUS SMOKE DETECTORS) SHALL NOT EXCEED 60 SECONDS. NO OTHER SMOKE DETECTORS SHALL BE CONNECTED TO THESE CIRCUITS UNLESS APPROVED BY THE LOCAL AUTHORITY HAVING JURISDICTION.

CIRCUIT CONTROL UNIT SMOKE DETECTORS ZONES DELAY-SEC
MODEL DELAY-SEC

THE DELAY (POWER UP) (STARTUP) TIME MARKED ON THE INSTALLATION WIRING DIAGRAM OF THE SMOKE DETECTOR OR ON THE INSTALLED SMOKE DETECTOR(S) IS TO BE USED.

UL GRADES FOR THE GEM-P9600

BURGLARY
LOCAL - GRADE A
POLICE STATION CONNECT BASIC LINE SECURITY - GRADE A
HOUSEHOLD BURGLARY ALARM CONTROL UNIT - GRADE A
HOUSEHOLD FIRE WARNING SYSTEM CONTROL UNIT
REFER TO WI742 FOR INSTALLATION REQUIREMENTS

E LUG FUNCTIONS

ULIG	DESCRIPTION
E14	FUSED +12V BATT POWER
E18	PS-30VDC BATTERY TEST OUTPUT
E7	PS-30VDC NO AC INPUT
E5	LUSTEN IN
E4	BURGLUG START
E4	ARM LUG
E4	TEST LUG
E22	TEST LUG - DELAY COMMON

POWER UP SEQUENCE

- 1.) CONNECT AC POWER
- 2.) INSTALL STANDBY BATTERY

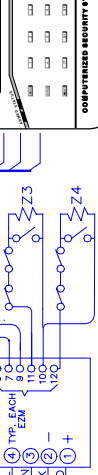
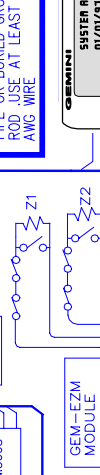
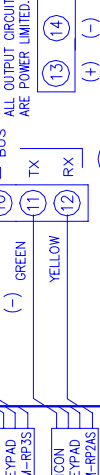
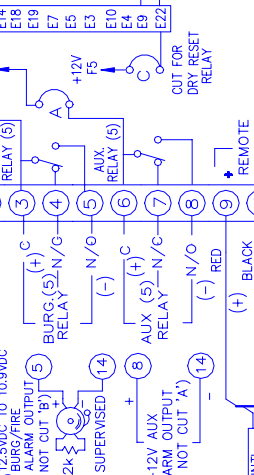
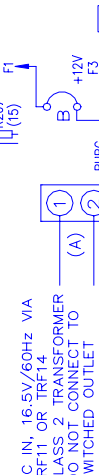
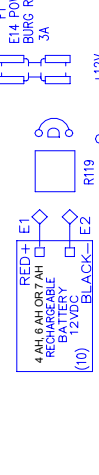
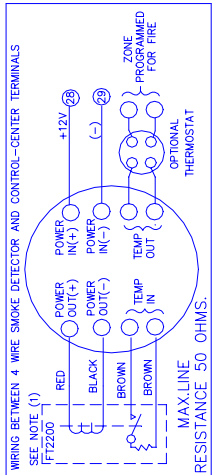

WARNING
TO PREVENT RISK OF ELECTRIC SHOCK DISCONNECT TELEPHONE LINES PRIOR TO SERVICING

BATTERY STANDBY CURRENT

RESIDENTIAL AND COMMERCIAL BURGLARY	STANDBY/ALARM CURRENT
COMBINED	PANEL
BATTERY STANDBY CURRENT	ALARM CURRENT
4 AH	750mA
7 AH	750mA
RESIDENTIAL FIRE AND COMBINATION BURGLARY AND FIRE	STANDBY/ALARM CURRENT
COMBINED	PANEL
BATTERY STANDBY CURRENT	ALARM CURRENT
7AH	150mA (3)
	650mA (3)
	24 HOURS

LA1234F



STATEMENT FOR CANADIAN MODELS

NOTICE: The Canadian Department of Communications label identifies certified equipment. This certification means that the equipment meets certain telecommunications network protective, operational and safety requirements. The Department does not guarantee the equipment will operate to the user's satisfaction.

Before installing this equipment, users should ensure that it is permissible to be connected to the facilities of the local telecommunications company. The equipment must also be installed using an acceptable method of connection. In some cases, the company's inside wiring associated with a single line individual service may be extended by means of a certified connector assembly (telephone extension cord). The customer should be aware that compliance with the above conditions may not prevent degradation of service in some situations.

Repairs to certified equipment should be made by an authorized Canadian maintenance facility designated by the supplier. Any repairs or alterations made by the user to this equipment, or equipment malfunctions, may give the telecommunications company cause to request the user to disconnect the equipment.

Users should ensure for their own protection that the electrical ground connections of the power utility, telephone lines and internal metallic water pipe system, if present, are connected together. This precaution may be particularly important in rural areas.

Caution: Users should not attempt to make such connections themselves, but should contact the appropriate electric inspection authority, or electrician, as appropriate.

NOTICE: The ringer Equivalence Number (REN) assigned to each terminal device provides an indication of the maximum number of terminals allowed to be connected to telephone interface. The termination of an interface may consist of any combination of devices subject only to the requirement that the sum of the Ringer Equivalence Numbers of all the devices does not exceed 5.

CSA-LISTED TRANSFORMERS

The following power transformers are CSA-Listed.
Magnetic Consultants: MG1620, MG1630, *MG1640*, PG1620
Frost: FTC2016, FTC3016, FTC4016
Hammond: BD2F

This digital apparatus does not exceed Class A limits for radio noise emissions from digital apparatus set out in the Radio Interference Regulations of the Canadian Department of Communications.

Le present appareil numerique n'emet pas de bruits radioelectriques les depassant les limites applicables aux appareils numeriques de la classe A prescrites dans le Reglement sur le brouillage radioelectrique edicte par le Ministere des Communications du Canada.

FCC STATEMENT

This equipment generates and uses radio-frequency energy and, if not installed and used properly, that is, in strict accordance with the manufacturer's instructions, may cause interference to radio and television reception. It has been type tested and found to comply with the limits for a Class-B computing device in accordance with the specifications in Subpart J of Part 15 of FCC Rules, which are designed to provide reasonable protection against such interference in a residential installation.

However, there is no guarantee that interference will not occur in a particular installation. If this equipment does cause interference to radio or television reception, which can be determined by turning the equipment off and on, the user is encouraged to try to correct the interference by one or more of the following measures: reorient the receiving antenna; relocate the computer with respect to the receiver; move the computer away from the receiver; plug the computer into a different outlet so that computer and receiver are on different branch circuits.

If necessary, the user should consult the dealer or an experienced radio/television technician for additional suggestions. The user may find the following booklet prepared by the Federal Communications Commission helpful: "How to Identify and Resolve Radio-TV Interference Problems". This booklet is available from the U.S. Government Printing Office, Washington, DC 20402; Stock No. 004-000-00345-4.

CAUTION: This equipment generates and uses radio-frequency energy. If not installed using conventional installation practices for RF devices, it may cause interference to radio and television reception. It has been tested and found to comply with the limits for a Class A computing device pursuant to Subpart B of Part 15 of FCC Rules, which are designed to provide reasonable protection against such interference. However, there is no guarantee that interference will not occur in a particular installation. If it has been found to cause interference to radio or television reception, which can be determined by removing and reapplying AC and battery power to the equipment, the installer should try to correct the interference by one or more of the following measures: reorient the receiving antenna; connect the power transformer to a different outlet so that the control panel and receiver are on different branch circuits; relocate the control panel with respect to the receiver.



NAPCO LIMITED WARRANTY

NAPCO SECURITY SYSTEMS, INC. (NAPCO) warrants its products to be free from manufacturing defects in materials and workmanship for *thirty-six months* following the date of manufacture. NAPCO will, within said period, at its option, repair or replace any product failing to operate correctly without charge to the original purchaser or user.

This warranty shall not apply to any equipment, or any part thereof, which has been repaired by others, improperly installed, improperly used, abused, altered, damaged, subjected to acts of God, or on which any serial numbers have been altered, defaced or removed. Seller will not be responsible for any dismantling or reinstallation charges.

THERE ARE NO WARRANTIES, EXPRESS OR IMPLIED, WHICH EXTEND BEYOND THE DESCRIPTION ON THE FACE HEREOF. THERE IS NO EXPRESS OR IMPLIED WARRANTY OF MERCHANTABILITY OR A WARRANTY OF FITNESS FOR A PARTICULAR PURPOSE. ADDITIONALLY, THIS WARRANTY IS IN LIEU OF ALL OTHER OBLIGATIONS OR LIABILITIES ON THE PART OF NAPCO.

Any action for breach of warranty, including but not limited to any implied warranty of merchantability, must be brought within the six months following the end of the warranty period.

IN NO CASE SHALL NAPCO BE LIABLE TO ANYONE FOR ANY CONSEQUENTIAL OR INCIDENTAL DAMAGES FOR BREACH OF THIS OR ANY OTHER WARRANTY, EXPRESS OR IMPLIED, EVEN IF THE LOSS OR DAMAGE IS CAUSED BY THE SELLER'S OWN NEGLIGENCE OR FAULT.

In case of defect, contact the security professional who installed and maintains your security system. In order to exercise the warranty, the product must be returned by the security professional, shipping costs prepaid and insured to NAPCO. After repair or replacement, NAPCO assumes the cost of returning products under warranty. NAPCO shall have no obligation under this warranty, or otherwise, if the product has been repaired by others, improperly installed, improperly used, abused, altered, damaged, subjected to accident, nuisance, flood, fire or acts of God, or on which any serial numbers have been altered, defaced or removed. NAPCO will not be responsible for any dismantling, reassembly or reinstallation charges.

This warranty contains the entire warranty. It is the sole warranty and any prior agreements or representations, whether oral or written, are either merged herein or are expressly cancelled. NAPCO neither assumes, nor

authorizes any other person purporting to act on its behalf to modify, to change, or to assume for it, any other warranty or liability concerning its products.

In no event shall NAPCO be liable for an amount in excess of NAPCO's original selling price of the product, for any loss or damage, whether direct, indirect, incidental, consequential, or otherwise arising out of any failure of the product. Seller's warranty, as hereinabove set forth, shall not be enlarged, diminished or affected by and no obligation or liability shall arise or grow out of Seller's rendering of technical advice or service in connection with Buyer's order of the goods furnished hereunder.

NAPCO RECOMMENDS THAT THE ENTIRE SYSTEM BE COMPLETELY TESTED WEEKLY.

Warning: Despite frequent testing, and due to, but not limited to, any or all of the following; criminal tampering, electrical or communications disruption, it is possible for the system to fail to perform as expected. NAPCO does not represent that the product/system may not be compromised or circumvented; or that the product or system will prevent any personal injury or property loss by burglary, robbery, fire or otherwise; nor that the product or system will in all cases provide adequate warning or protection. A properly installed and maintained alarm may only reduce risk of burglary, robbery, fire or otherwise but it is not insurance or a guarantee that these events will not occur. CONSEQUENTLY, SELLER SHALL HAVE NO LIABILITY FOR ANY PERSONAL INJURY, PROPERTY DAMAGE, OR OTHER LOSS BASED ON A CLAIM THE PRODUCT FAILED TO GIVE WARNING. Therefore, the installer should in turn advise the consumer to take any and all precautions for his or her safety including, but not limited to, fleeing the premises and calling police or fire department, in order to mitigate the possibilities of harm and/or damage.

NAPCO is not an insurer of either the property or safety of the user's family or employees, and limits its liability for any loss or damage including incidental or consequential damages to NAPCO's original selling price of the product regardless of the cause of such loss or damage.

Some states do not allow limitations on how long an implied warranty lasts or do not allow the exclusion or limitation of incidental or consequential damages, or differentiate in their treatment of limitations of liability for ordinary or gross negligence, so the above limitations or exclusions may not apply to you. This Warranty gives you specific legal rights and you may also have other rights which vary from state to state.